

# 全球 Global Strategy 战略

携手共进 合作共赢



集研发设计、生产制造、销售与技术咨询服务  
于一体的专业型电源公司

A professional power company integrates R&D, design,  
production, sales and technical service.

深圳市吉宏达电子有限公司  
SHEN ZHEN JIHONGDA POWER CO.,LTD  
地址：深圳市宝安区福永街道凤凰社区兴业一路6号第22栋 第四、五层

电话：86-0755-27335173  
传真：86-0755-27335196  
网址：[www.jhdpower.com](http://www.jhdpower.com)  
邮箱：[kevin@jhdpower.com](mailto:kevin@jhdpower.com)

吉宏达电子有限公司  
JHD ELECTRONICS LIMITED

深圳市吉宏达电子有限公司  
SHEN ZHEN JIHONGDA POWER CO.,LTD

INTRODUCTION

# E 企业简介 Enterprise Profile

深圳市吉宏达电子有限公司--成立于2006年6月，位于交通发达的是中国改革开放前沿城市-深圳市宝安区福永镇。公司拥有员工280余人，其办公与生产车间面积达3500平方米。

公司专业从事开关电源开发设计、生产制造、销售与技术咨询服务一体的专业型电源公司。拥有一批电源行业多年设计经验的高级工程师以及经验丰富的生产、品质管理人员等组成的高管理团队。拥有完善的品质管理体系。产品包括：AC/DC适配器、智能数码充电器、基板电源以及DC-DC转换器，产品上千余种机型，并根据客户要求专门订制、开发特殊电源。

公司产品采用国际先进控制电路、优质品牌供应商等电子元件，吸收国内外优良技术。其电源产品工作稳定性强、可靠性高、对抗干扰及电磁兼容性符合国际电工标准。产品通过：CB、CCC、UL(cul)、FCC、PSE、CE、GS、SAA、S-MARK、E-MARK等全球多国安规认证；符合欧盟ERP、美国CEC、DOE等能效标准及相关证书。采用全无铅（ROHS、REACH）标准制程。产品遍及中国、东南亚、欧洲、美洲、中东以及非洲等多个国家。其涉及领域包括：数码设备充电、家用电器、音视频电视/音响、照明、通信网络、美容保健产品、数码监控以及工业控制等类别；广泛应用于：手机、平板电脑、笔记本电脑、收银机、手持扫描仪、电视、显示器、网络数码设备（机顶盒、集线器、数码转换器）、LED节能照明灯、摄像头、电池充电器、可视电话、仪器仪表、银行数据设备、电脑周边产品、安防监控、医疗设备、通讯设备、工业及税控打印设备等产品。

公司严格执行ISO9001：2015质量体系的框架下；奉行以“品质优先、稳步发展、服务社会”为企业宗旨；以“专注、专业、务实、创新”为企业精神；设计、生产“安全、节能、高效、优质”的产品，追求“携手共进、合作共赢、共享荣誉”的企业文化；结合最先进的生产自动化设备，创造符合国际标准一流的产品，以达到产品质量、服务速度、成本控制、工作效率等方面的最佳优势。

Shenzhen Jihongda Power Co.,Ltd., established in June 2006, is a professional manufacturer and exporter that is concerned with the design, development and production of power supply products. We are located in Baoan district ,Shenzhen city, with convenient transportation access. We have over 280 employees, office and workshop area of 3500m<sup>2</sup>.All of our products comply with international quality standards and are greatly appreciated in a variety of different markets throughout the world.

Our company specializes in switch power supply development and design, manufacturing, sales and technical advisory services integrated professional power supply company, power industry has a number of years of design experience of senior engineers and experienced production, quality management personnel composed of high management team. We have a sound quality management system. Products include AC/DC adapter, smart digital charger, substrate power supply and DC-DC converter, more than a thousand types of products, and according to customer requirements to customize and develop special power supply.

The company adopts international advanced control circuits, quality brand suppliers and other electronic components, and absorbs excellent technology at home and abroad. Its power supply products have strong working stability, high reliability, anti-interference and electromagnetic compatibility with international electrical standards. Products have passed: CB,CCC, UL(cul),FCC, PSE, CE,GS, SAA,S-MARK,E-MARK and other global multi-national security certification: comply with EU ERP,US CEC,DOE and other energy efficiency standards and relevant certificates. Adopt all lead free(ROHS, REACH) standard process. Products throughout China, southeast Asia, Europe, America, the Middle East and Africa and other countries. Its fields include: digital equipment charging, household appliances, audio and video television/audio, lighting, communication networks, beauty and health products, digital monitoring and industrial control and other categories: widely used in mobile phone, tablet, notebook computers, cash registers, handheld scanners, digital TV, display, network equipment, computer peripheral products, security monitoring, medical equipment, communications equipment, industrial, and ensure the printing equipment and other products.

Our company strictly implements ISO9001:2015 quality system. For the purpose of our enterprise "Quality first, steady development, service society", to "focus, professional, pragmatic, innovative" as the spirit of our enterprise. Design, production of "safe, energy-saving, efficient and high-quality" products, the pursuit of "work together ,win-win cooperation, sharing honor " corporate culture. Combining with the most advanced production automation equipment, to create world-class products in line with international standards, in order to achieve product quality, service speed, cost control, efficiency and

- 01 企业简介  
Enterprise Profile
- 03 企业文化  
Corporate Culture
- 05 经营团队  
Management Team
- 06 组织架构  
Organization Structure
- 07 企业荣誉  
Corporate Honor
- 09 发展历程  
Development History
- 11 品质管控流程  
Quality Control Process
- 12 生产工艺流程  
Production Technology Process
- 13 公司风采  
Company Style
- 15 产品寻求  
Product Seeking



# CORPORATE CULTURE

## 企业文化

# CULTURE



**核心价值观:**“携手共进、合作共赢、共享荣誉”  
**经营理念:**“专注、专业、务实、创新”  
**管理理念:**“务实、创新、服务、效率”  
**产品理念:**“安全、节能、高效、优质”  
**质量方针:**“客为中心、品质为本、创新求精、持续改进”  
**发展方针:**“品质优先、稳步发展。做对客户和社会负责任的企业”  
**企业目标:**“创造符合国际标准一流的产品，服务国际一流的客户”

**Core Values:** “work together, win-win cooperation, share honor”  
**Business Philosophy:** “dedicated, professional, pragmatic, innovative”  
**Management Philosophy:** “pragmatism, innovation, service and efficiency”  
**Product Philosophy:** “safety, energy saving, high efficiency, high quality”  
**Quality Policy:** “customer-centered, quality-oriented, innovation and refinement, continuous improvement”  
**Development Policy:** “quality priority, steady development. To be a responsible enterprise for customers and society.”  
**Enterprise Objective:** “To create first-class products in line with international standards, to serve world-class customers”

# ORGANIZATION STRUCTURE

## 组织架构

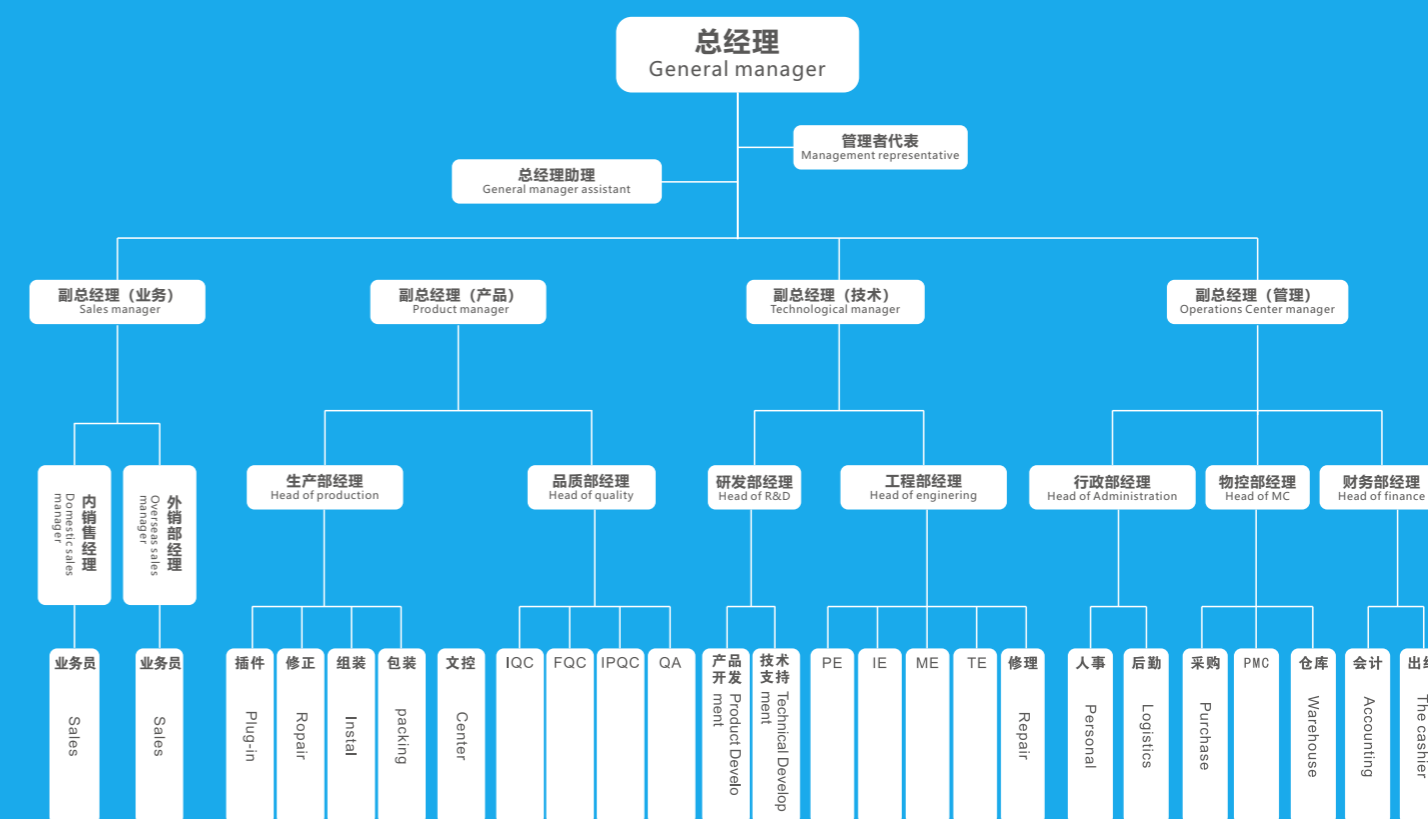

# MANAGEMENT TEAM

## 经营团队



我们的团队：团结、诚信、务实、专注、敬业、追求卓越。

Our Team: unity, integrity, pragmatism, focus, dedication, the pursuit of excellence.



CCC



UL(cul)



FCC



CB



SAA



S-MARK



PSE



CE



GS



E-MARK



ISO9001:2015



外观专利



# CORPORATE HONOR 企业荣誉

## 集设计、开发，制造，销售与技术咨询服务 于一体的专业型电源公司

A professional power company integrates R&D、design、  
production、sales and technical service.

## 发展历程 EVELOPMENT HISTORY

### ◀2018年

公司完成QC2.0、QC3.0、PD18W、PD30W、PD45W、PD60W、PD30W-A+C接口等智能协议充电器的开发和相关认证，荣获深圳市高新技术企业。产品年销售量750万台。  
The company has completed the development and related certification of intelligent protocol chargers such as QC2.0, QC3.0, PD18W, PD30W, PD45W, PD60W, PD30W-A+C interface, and won the honor of Shenzhen High-tech Enterprise. The annual sales volume of the product is 7.5 million.

### ◀2017年

扩大工厂规模，办公+生产车间达3500平方米；员工增加到250余人；公司通过ISO9001:2015版换证审核。产品年销售量达到750万台 Expand the size of the factory, Office + production workshop up to 3500 square meters, the number of employees increased to more than 250 people, the company passed the ISO9001:2015 version of the certificate replacement audit. Annual sales of products reached 7.5 million units.

### ◀2016年

公司将5W-65W电源全系列化，增加：中规、美规、日规、欧规、英规、澳大利亚规、阿根廷规、巴西规、印度规、韩规等产品的完善。年销售量突破650万台。  
The company serialized the entire power supply of 5w-65w, and added the improvement of Chinese, American, Japanese, European, British, Australian, Argentine, Brazilian, Indian, Korean and other products. The annual sales topped 6.5 million units.

### ◀2015年

开发设计36W系列适配器，并取得CCC、UL、PSE、CB、CE等相关国内、国际安规认证证书。年销售量550万台。  
Development and design of 36W series adapters, and obtain CCC, UL, PSE, CB, CE and other related domestic and international security certificates. The annual sales of 5.5 million units.

### ◀2014年

开发设计24W系列适配器，并取得CCC、UL、PSE、CB、CE等相关国内、国际安规认证证书，公司通过ISO9001:2008证书，年销售量450万台。  
Development and design of 24W series adapters, and obtained CCC, UL, PSE, CB, CE and other related domestic and international security certificates, the company passed the ISO 9001:2008 certificate, the annual sales of 4.5 million units.

### ◀2013年

开发设计15W系列适配器，并取得CCC、UL、PSE、CB、CE等相关国内、国际安规认证证书，年销售量350万台。  
Development and design of 15W series adapters, and obtained CCC, UL, PSE, CB, CE and other related domestic and international security certificates, annual sales of 3.5 million units.

### ◀2012年

开发设计12W系列适配器，并取得CCC、UL、PSE、GS、CB、CE、等相关国内、国际安规认证证书，年销售量250万台。  
Development and design of 12W series adapters, and obtained CCC, UL, PSE, GS, CB, CE, and other related domestic and international security certificates, annual sales of 2.5 million units.

### ◀2011年

成立香港吉宏达科技有限公司，公司开始服务海外客户；同时公司成功开发65W桌面式系列电源并取得CB、UL (cul)、PSE、GS证书；公司出货量突破200万台；  
The establishment of Hong Kong Ji Hongda Technology Co., Ltd., the company began to serve overseas customers, at the same time the company successfully developed 65W desktop series power supply and obtained CB, UL (cul), PSE, GS certificate; The company shipments exceeded 2 million units;

### ◀2010年

开发设计5W系列适配器，并取得CCC、UL、PSE、GS、CB、CE、SAA等相关国内、国际安规认证证书，年销售量135万台。  
Development and design of 5W series adapters, and obtained CCC, UL, PSE, GS, CB, CE, SAA and other related domestic and international security certificates, annual sales of 1.35 million units.

### ◀2009年

以机顶盒市场为主，开发全系列机顶盒电源，年销售量突破100万台。  
Mainly in the set-top box market, we have developed a full range of set-top box power supply, with annual sales exceeding 1 million units.

### ◀2008年

成立电源生产工厂，公司迁移到工厂办公，工厂面积1500平方米，成立电技术中心，主要针对客户定做产品开发、生产、销售。  
Set up a power supply production plant, the company moved to factory work, factory area of 1500 square meters, set up an electrical technology center, mainly for customers customized product development, production, sales.

### ◀2006年

深圳市吉宏达电子有限公司成立于深圳市南山科技园，以设计开发、销售为主。  
Shenzhen Ji Hongda Electronics CO., Ltd. was established in Shenzhen Nanshan Science and Technology Park, focusing on design, development and sales.

# QUALITY CONTROL PROCESS

## 品质管控流程图

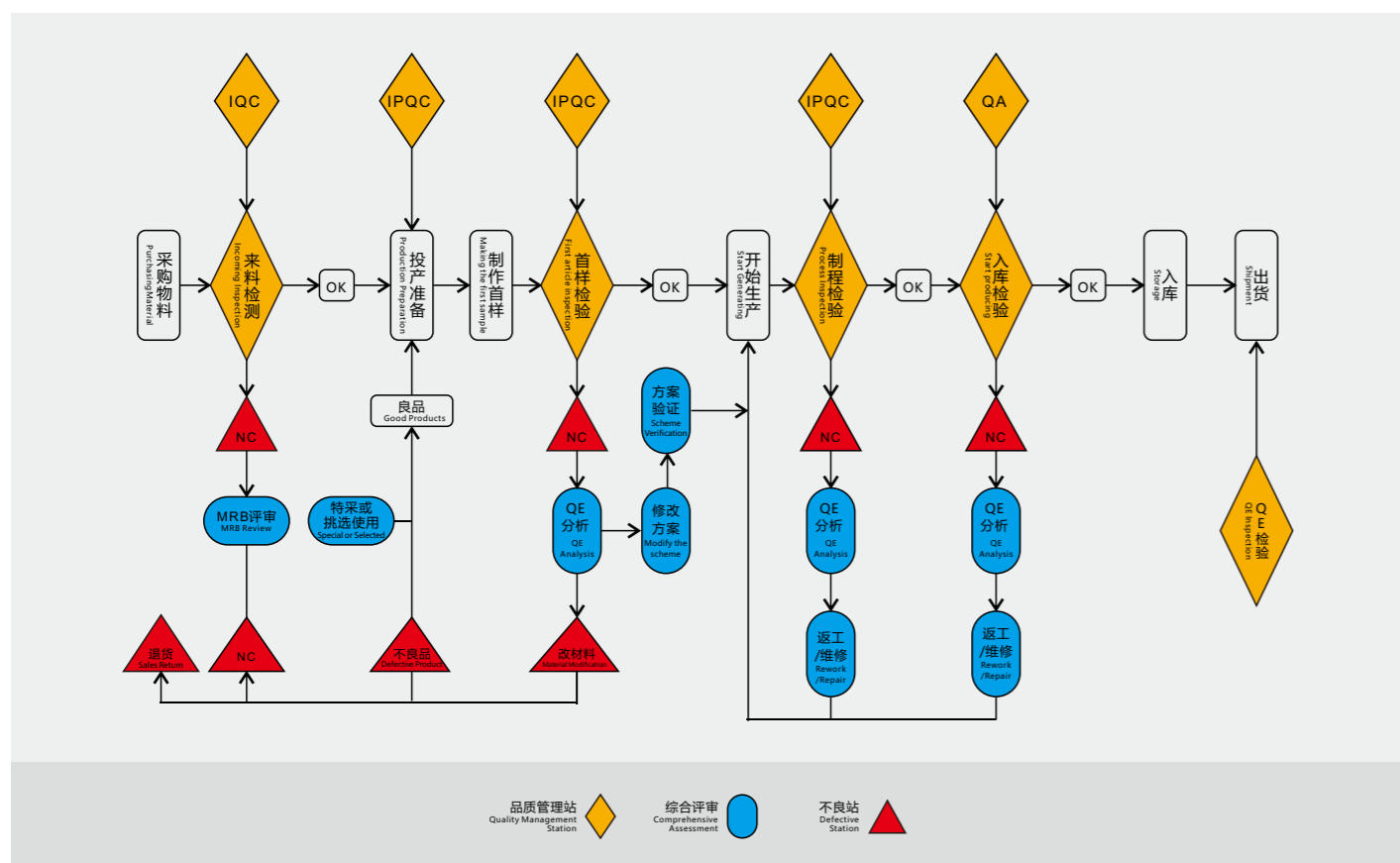

产品准时交货率≥98%  
Punctual delivery rate≥98%

顾客满意度≥95%  
Customer Satisfaction≥95%

产品出货质量目标: ≤100PPM  
Product shipment quality target: ≤100PPM

客户有效投诉处理率100%  
Effectively Customer complaint handle rate100%

# PRODUCTION TECHNOLOGY PROCESS

## 生产工艺流程图

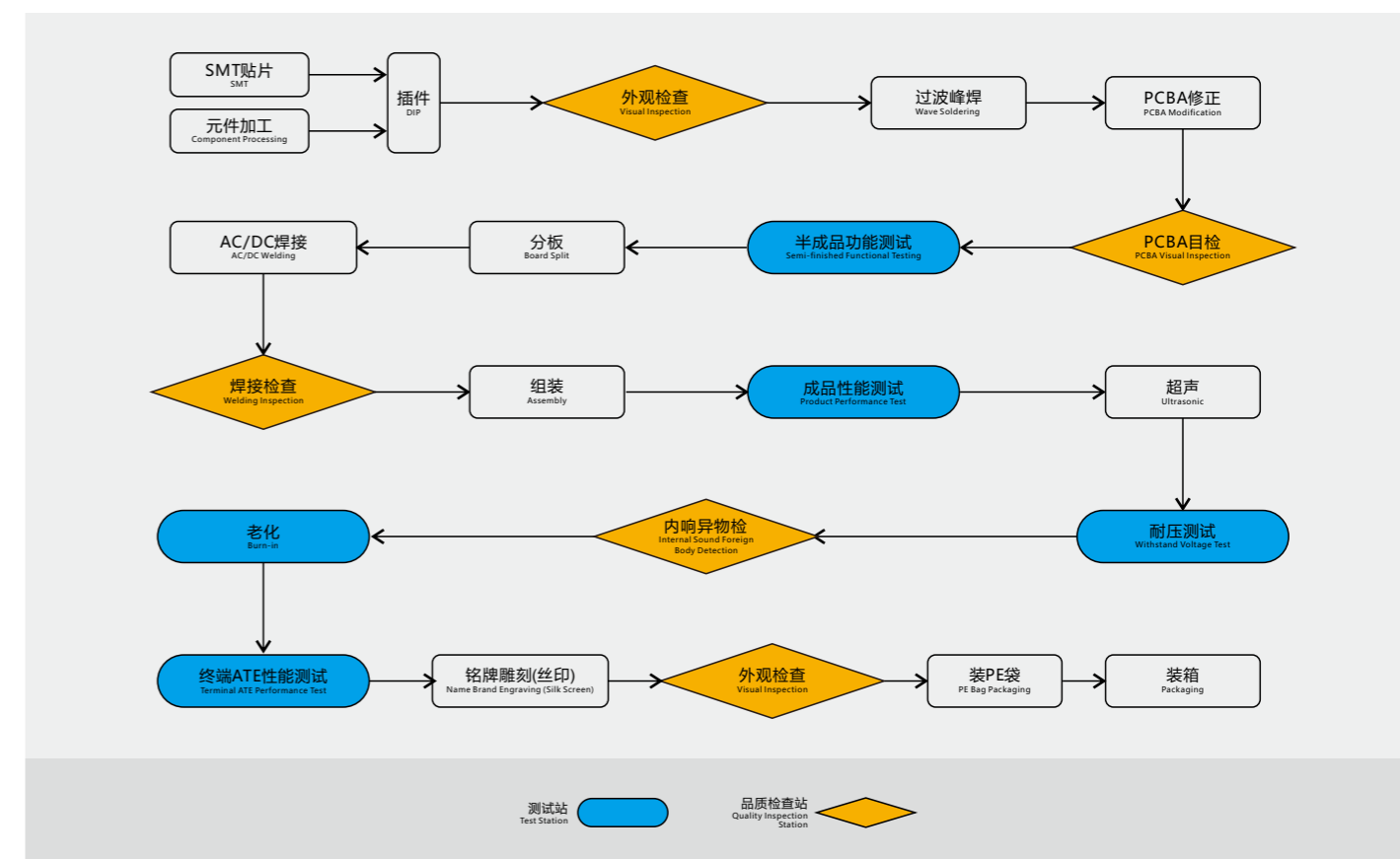

本公司严格执行ISO9001: 2015标准, 结合公司自动化生产设备, 100%执行以上生产流程。确保给客户的每一个产品都经过严格的生产管控。有效保障产品客户在使用产品过程中的安全和质量稳定。

The company strictly implements the ISO 9001:2015 standard, combined with the company's automated production equipment, 100% of the implementation of the above production process. Ensure that every product given to the customer is subject to strict production control. Effectively ensure the safety and quality stability of product customers in the process of using products.



# COMPANY

## STYLE 公司风采

整理 ( SEIRI )    整顿 (SEITON)    清扫 (SEISO)    清洁 (SEIKETSU)  
 素养 (SHITSUKU)    安全 (SAFETY)    节约 (SAVE)    学习 ( STUDY )

8s管理法的目的, 是使企业现场管理的基础上, 通过创建学习型组织不断提升企业文化的素养, 消除安全隐患、节约成本和时间。使企业在激烈的竞争中, 永远立于不败之地。

The purpose of 8s management law is to make the enterprise improve its cultural accomplishment, eliminate hidden safety hazards, save cost and time by creating learning organization on the basis of on-site management. Make the enterprise in the fierce competition, always in an invincible position.





# 6W

**JHD MORE+** www.jhdpower.com

DC/Lenovo/TYPER-C/MICRO



### CCC中規

Input Characteristics  
Input voltage: 100-240VAC  
Input frequency: 47-63HZ

### UL美規/PSE日規 NOM墨西哥/BSMI台灣

Input Characteristics  
Input voltage: 100-240VAC  
Input frequency: 47-63HZ



### DC:6W

output voltage: DC5-24V  
output current: 0.01-1.2A  
DC: 5V1A/5V1.2A/6V1A/12V0.5A/24V0.24A  
product certificate: CB, CCC(CECP)



### DC:6W

output voltage: DC5-24V  
output current: 0.01-1.2A  
DC: 5V1A/5V1.2A/6V1A/12V0.5A/24V0.24A  
product certificate: CB, UL, FCC, PSE(ROHS/REACH/DOE/CEC/ICES)

### CE歐規/EAC俄羅斯

Input Characteristics  
Input voltage: 100-240VAC  
Input frequency: 47-63HZ

### Br巴西規

Input Characteristics  
Input voltage: 100-240VAC  
Input frequency: 47-63HZ



### DC:6W

output voltage: DC5-24V  
output current: 0.1-1.2A  
DC: 5V1A/5V1.2A/6V1A/12V0.5A/24V0.24A  
product certificate: CB, CE, EAC(ROHS/REACH/ICES/ERP)

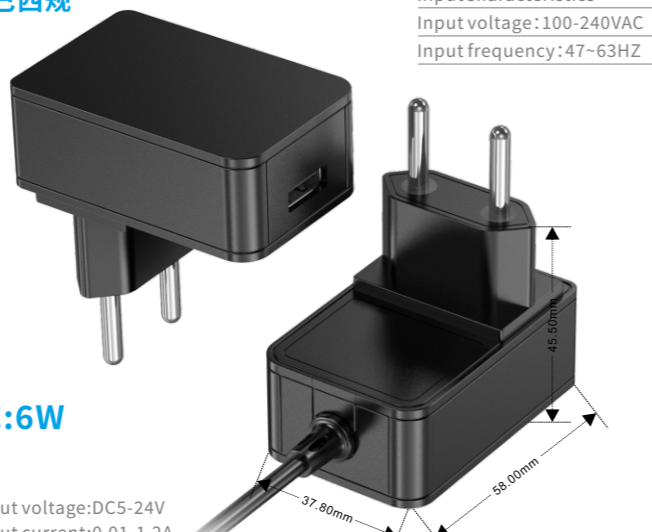

### DC:6W

output voltage: DC5-24V  
output current: 0.01-1.2A  
DC: 5V1A/5V1.2A/6V1A/12V0.5A/24V0.24A  
product certificate: CB, BR(ROHS/REACH/ICES/ERP)

### Kc韓國

Input Characteristics  
Input voltage: 100-240VAC  
Input frequency: 47-63HZ

### S-MARK阿根廷

Input Characteristics  
Input voltage: 100-240VAC  
Input frequency: 47-63HZ

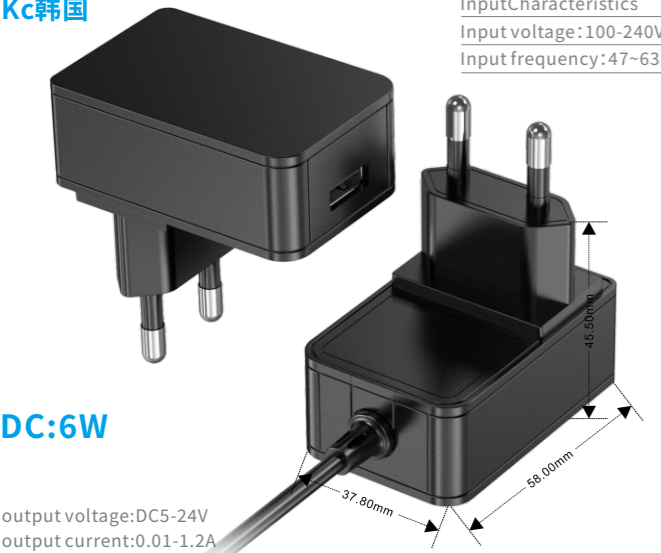

### DC:6W

output voltage: DC5-24V  
output current: 0.01-1.2A  
DC: 5V1A/5V1.2A/6V1A/12V0.5A/24V0.24A  
product certificate: CB, KC, KCC(MEPS/ROHS/REACH/ERP)



### DC:6W

output voltage: DC5-24V  
output current: 0.01-1.2A  
DC: 5V1A/5V1.2A/6V1A/12V0.5A/24V0.24A  
product certificate: CB, S-MARK(ROHS/REACH/ERP)

# 6W

**JHD MORE+** www.jhdpower.com

DC/Lenovo/TYPER-C/MICRO

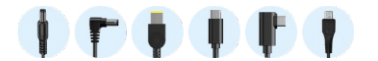

### SAA澳大利亞

Input Characteristics  
Input voltage: 100-240VAC  
Input frequency: 47-63HZ

### BIS印度規

Input Characteristics  
Input voltage: 100-240VAC  
Input frequency: 47-63HZ

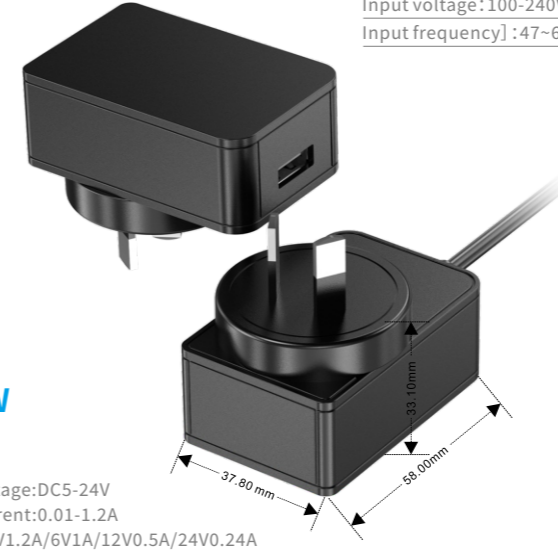

### DC:6W

output voltage: DC5-24V  
output current: 0.01-1.2A  
DC: 5V1A/5V1.2A/6V1A/12V0.5A/24V0.24A  
product certificate: SAA, C-tick (GEMS/ROHS/REACH/ERP)

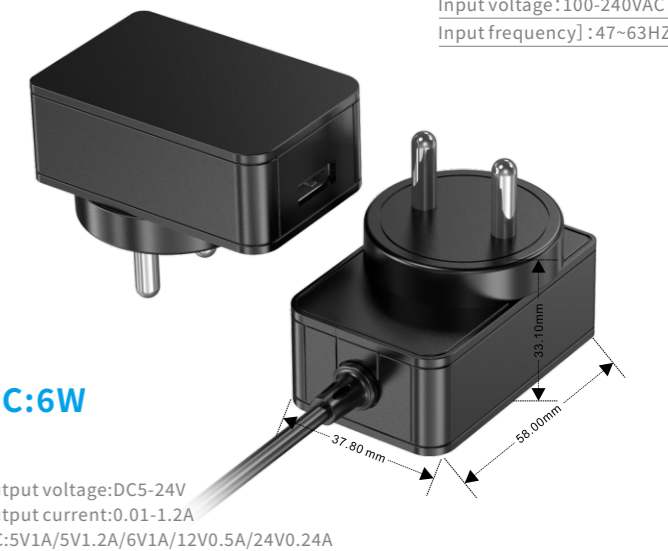

### DC:6W

output voltage: DC5-24V  
output current: 0.01-1.2A  
DC: 5V1A/5V1.2A/6V1A/12V0.5A/24V0.24A  
product certificate: CB, BIS(/ROHS/REACH/ERP)

### Bs英國

Input Characteristics  
Input voltage: 100-240VAC  
Input frequency: 47-63HZ

### 插牆式可換頭

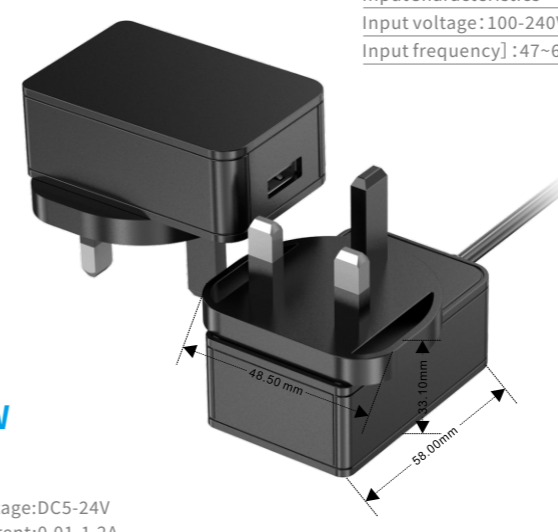

### DC:6W

output voltage: DC5-24V  
output current: 0.01-1.2A  
DC: 5V1A/5V1.2A/6V1A/12V0.5A/24V0.24A  
product certificate: CB, UKCA(ROHS/REACH/ERP)

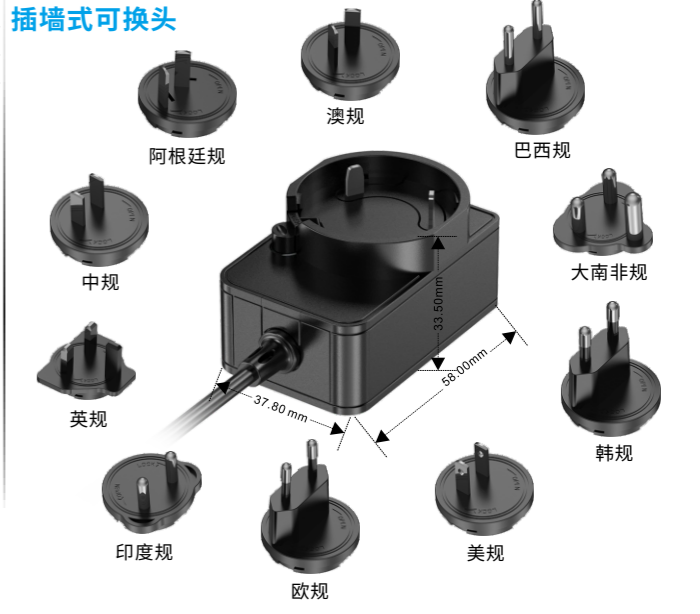

# 12W

**JHD** MORE+ www.jhdpower.com

DC/Lenovo/TYPER-C/MICRO



## CCC中規

Input Characteristics  
Input voltage: 100-240VAC  
Input frequency: 47-63HZ



## DC:12W

output voltage: DC5-12V  
output current: 0.01-2.1A  
DC: 5V2A/12V1A  
product certificate: CB, CCC(CECP)

## CE歐規/EAC俄羅斯

Input Characteristics  
Input voltage: 100-240VAC  
Input frequency: 47-63HZ

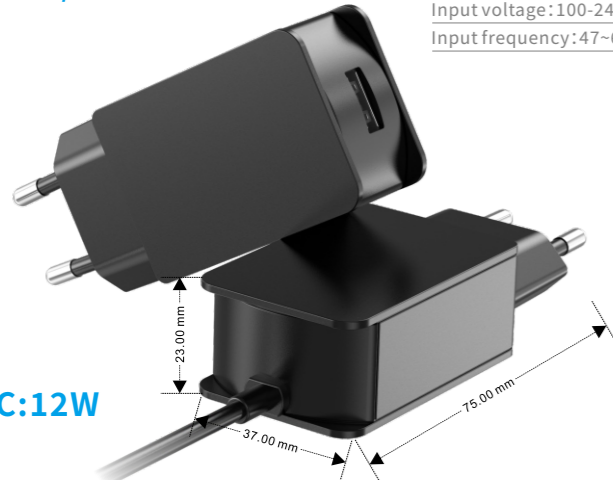

## DC:12W

output voltage: DC5-12V  
output current: 0.01-2.1A  
DC: 5V2A/12V1A  
product certificate: CB, CE, EAC(ROHS/REACH/ICES/ERP)

## Kc韓國

Input Characteristics  
Input voltage: 100-240VAC  
Input frequency: 47-63HZ

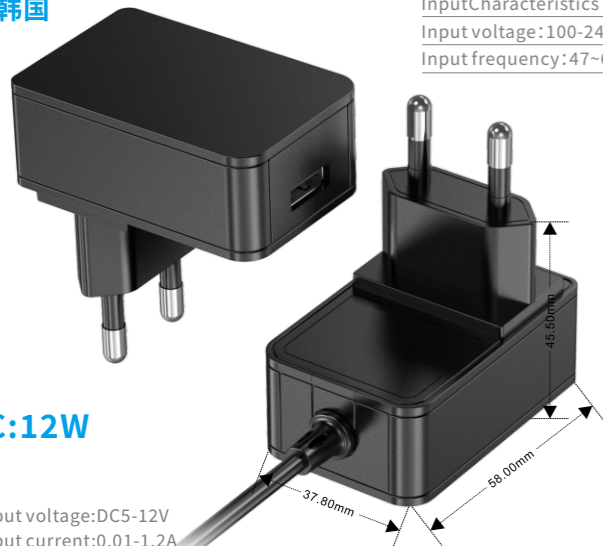

## DC:12W

output voltage: DC5-12V  
output current: 0.01-1.2A  
DC: 5V2A/12V1A  
product certificate: CB, KC, KCC(MEPS/ROHS/REACH/ERP)

## UL美規/PSE日規 NOM墨西哥/BSMI台灣

Input Characteristics  
Input voltage: 100-240VAC  
Input frequency: 47-63HZ



## DC:12W

output voltage: DC5-12V  
output current: 0.01-2.1A  
DC: 5V2A/12V1A  
product certificate: CB, UL, FCC, PSE(ROHS/REACH/DOE/CEC/ICES)

## Br巴西規

Input Characteristics  
Input voltage: 100-240VAC  
Input frequency: 47-63HZ

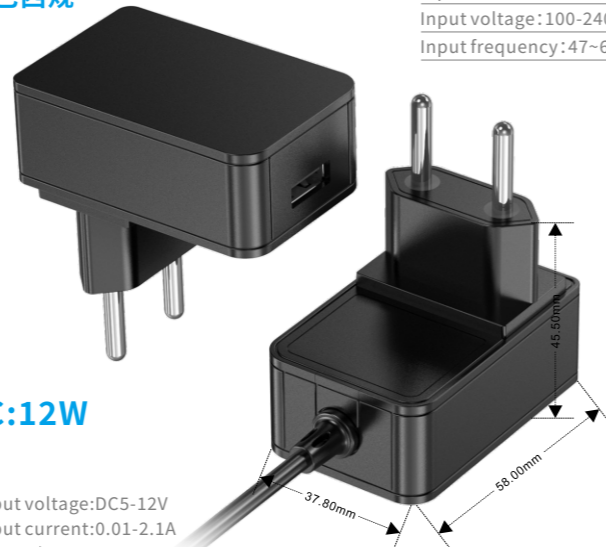

## DC:12W

output voltage: DC5-12V  
output current: 0.01-2.1A  
DC: 5V2A/12V1A  
product certificate: CB, BR(ROHS/REACH/ICES/ERP)

## S-MARK阿根廷

Input Characteristics  
Input voltage: 100-240VAC  
Input frequency: 47-63HZ

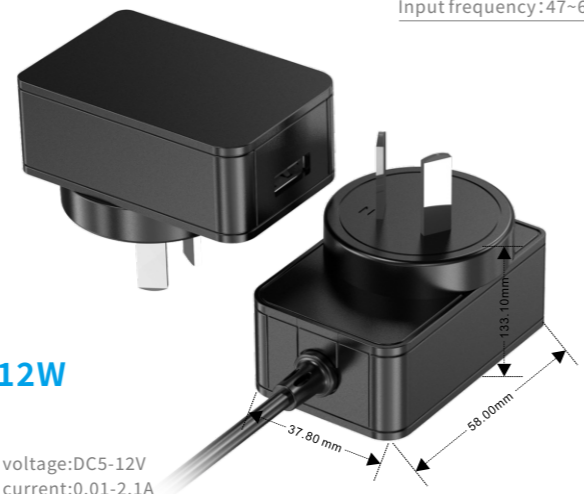

## DC:12W

output voltage: DC5-12V  
output current: 0.01-2.1A  
DC: 5V2A/12V1A  
product certificate: CB, S-MARK(ROHS/REACH/ERP)

# 12W

**JHD** MORE+ www.jhdpower.com

DC/Lenovo/TYPER-C/MICRO

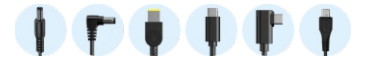

## SAA澳大利亞

Input Characteristics  
Input voltage: 100-240VAC  
Input frequency: 47-63HZ

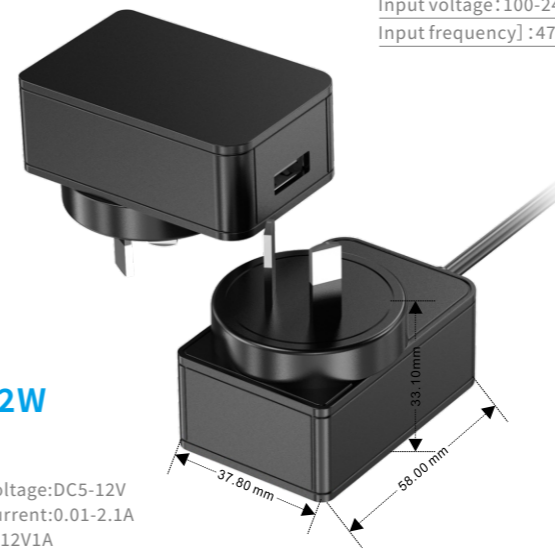

## DC:12W

output voltage: DC5-12V  
output current: 0.01-2.1A  
DC: 5V2A/12V1A  
product certificate: SAA, C-tick (GEMS/ROHS/REACH/ERP)

## Bs英國

Input Characteristics  
Input voltage: 100-240VAC  
Input frequency: 47-63HZ

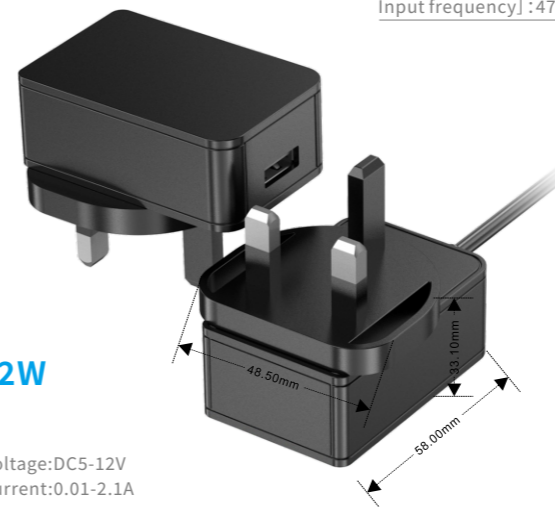

## DC:12W

output voltage: DC5-12V  
output current: 0.01-2.1A  
DC: 5V2A/12V1A  
product certificate: CB, UKCA(ROHS/REACH/ERP)

## BIS印度規

Input Characteristics  
Input voltage: 100-240VAC  
Input frequency: 47-63HZ

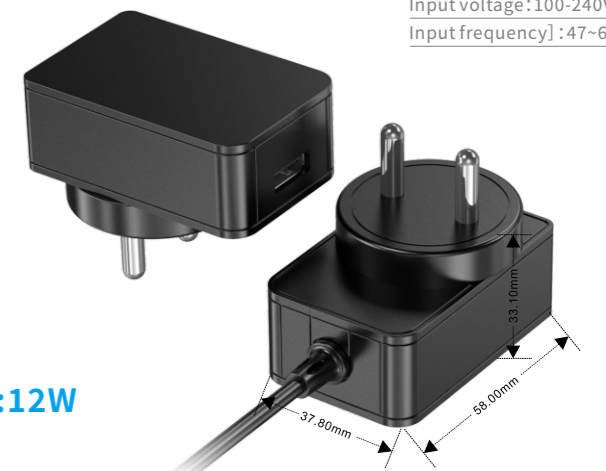

## DC:12W

output voltage: DC5-12V  
output current: 0.01-2.1A  
DC: 5V2A/12V1A  
product certificate: CB, BIS(/ROHS/REACH/ERP)

## 插牆式可換頭

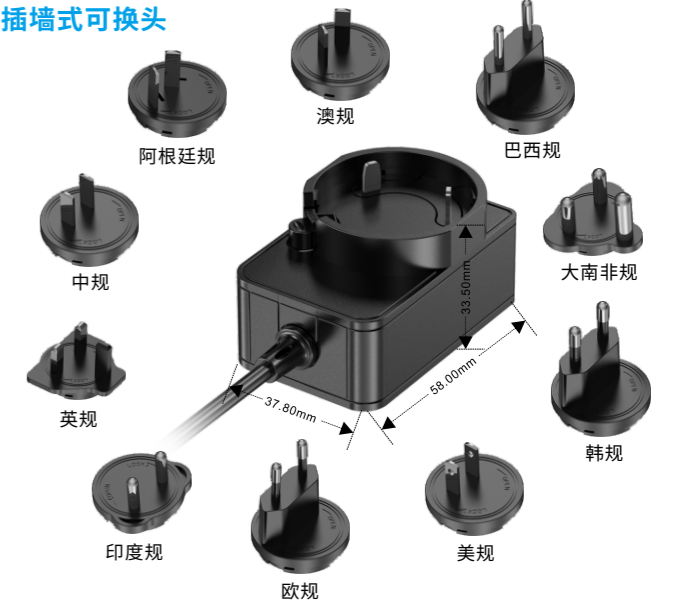

# 15W

**JHD** MORE+ www.jhdpower.com



## CCC中规

Input Characteristics  
Input voltage: 100-240VAC  
Input frequency: 47-63HZ

## UL美规/PSE日规 NOM墨西哥/BSMI台湾

Input Characteristics  
Input voltage: 100-240VAC  
Input frequency: 47-63HZ

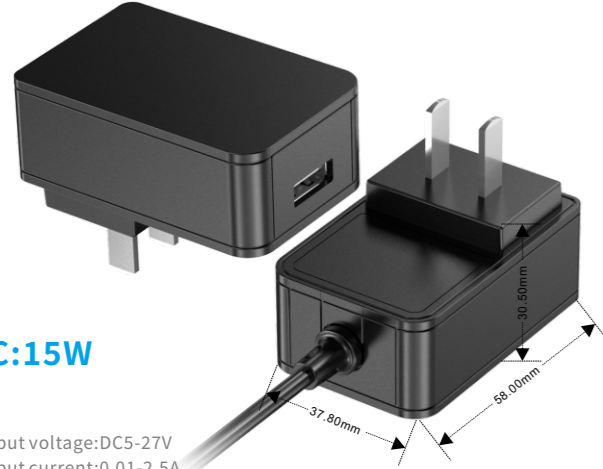

## DC:15W

output voltage: DC5-27V  
output current: 0.01-2.5A  
DC: 5V2A/5V2.5A, 12V1A/12V1.2A/15V1A/24V0.625A  
product certificate: CB, CCC(CECP)

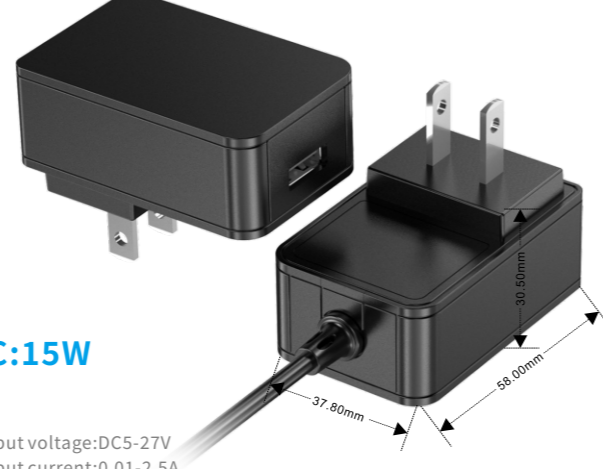

## DC:15W

output voltage: DC5-27V  
output current: 0.01-2.5A  
DC: 5V2A/5V2.5A, 12V1A/12V1.2A/15V1A/24V0.625A  
product certificate: CB, UL, FCC, PSE(ROHS/REACH/DOE/CEC/ICES)

## CE欧规/EAC俄罗斯

Input Characteristics  
Input voltage: 100-240VAC  
Input frequency: 47-63HZ

## Br巴西规

Input Characteristics  
Input voltage: 100-240VAC  
Input frequency: 47-63HZ

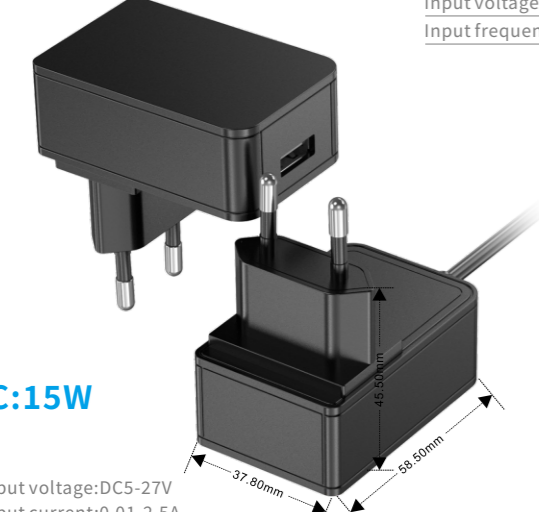

## DC:15W

output voltage: DC5-27V  
output current: 0.01-2.5A  
DC: 5V2A/5V2.5A, 12V1A/12V1.2A/15V1A/24V0.625A  
product certificate: CB, CE, EAC(ROHS/REACH/ICES/ERP)

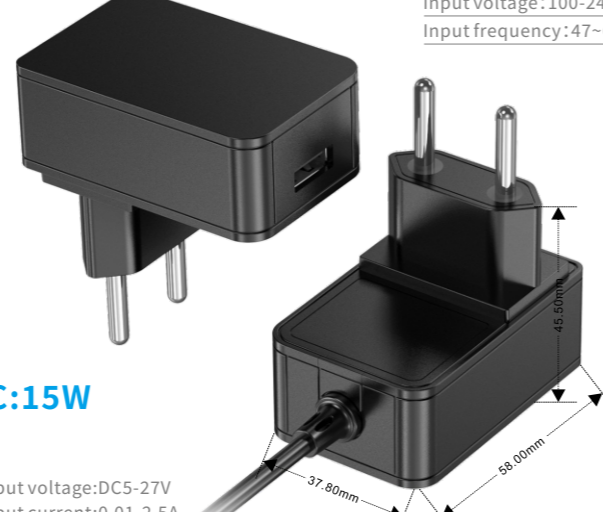

## DC:15W

output voltage: DC5-27V  
output current: 0.01-2.5A  
DC: 5V2A/5V2.5A, 12V1A/12V1.2A/15V1A/24V0.625A  
product certificate: CB, BR(ROHS/REACH/ICES/ERP)

## Kc韩国

Input Characteristics  
Input voltage: 100-240VAC  
Input frequency: 47-63HZ

## S-MARK阿根廷

Input Characteristics  
Input voltage: 100-240VAC  
Input frequency: 47-63HZ

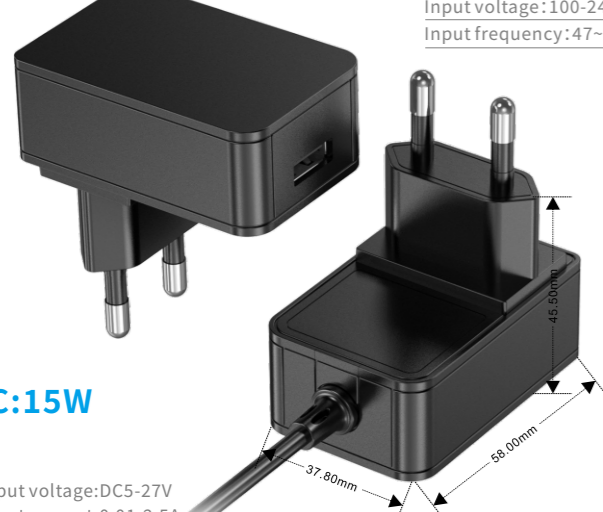

## DC:15W

output voltage: DC5-27V  
output current: 0.01-2.5A  
DC: 5V2A/5V2.5A, 12V1A/12V1.2A/15V1A/24V0.625A  
product certificate: CB, KC, KCC(MEPS/ROHS/REACH/ERP)

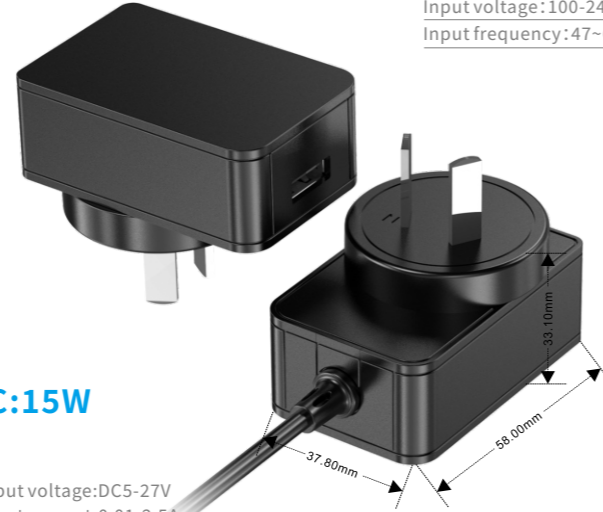

## DC:15W

output voltage: DC5-27V  
output current: 0.01-2.5A  
DC: 5V2A/5V2.5A, 12V1A/12V1.2A/15V1A/24V0.625A  
product certificate: CB, S-MARK(ROHS/REACH/ERP)

# 15W

**JHD** MORE+ www.jhdpower.com



## SAA澳大利亚

Input Characteristics  
Input voltage: 100-240VAC  
Input frequency: 47-63HZ

## BIS印度规

Input Characteristics  
Input voltage: 100-240VAC  
Input frequency: 47-63HZ

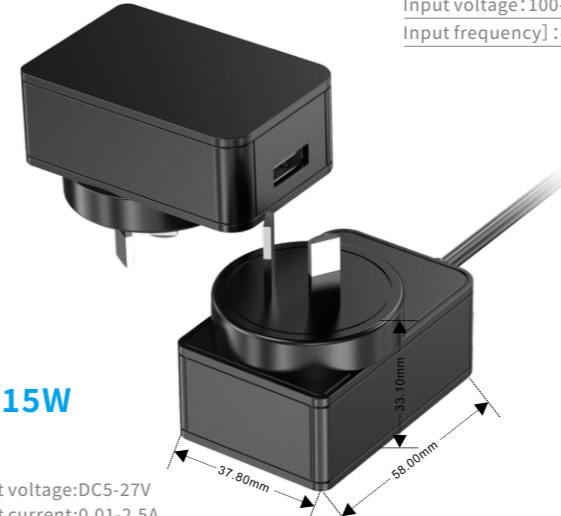

## DC:15W

output voltage: DC5-27V  
output current: 0.01-2.5A  
DC: 5V2A/5V2.5A, 12V1A/12V1.2A/15V1A/24V0.625A  
product certificate: SAA, C-tick (GEMS/ROHS/REACH/ERP)

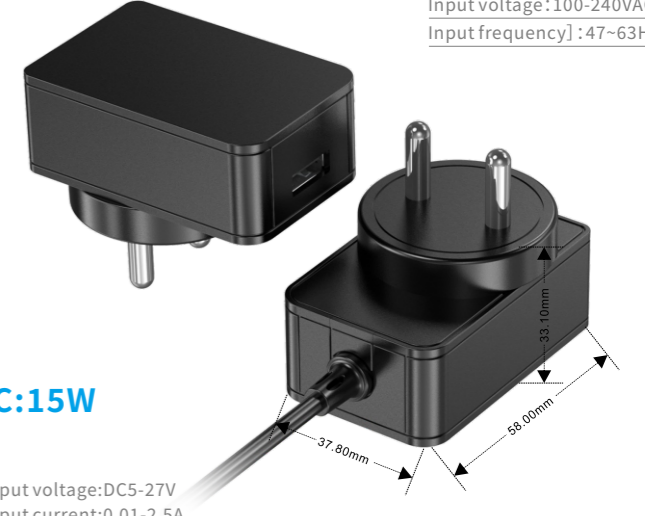

## DC:15W

output voltage: DC5-27V  
output current: 0.01-2.5A  
DC: 5V2A/5V2.5A, 12V1A/12V1.2A/15V1A/24V0.625A  
product certificate: CB, BIS(/ROHS/REACH/ERP)

## Bs英国

Input Characteristics  
Input voltage: 100-240VAC  
Input frequency: 47-63HZ

## 插墙式可换头

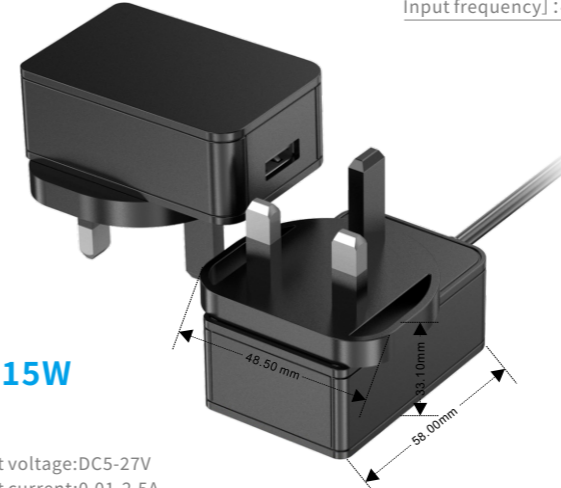

## DC:15W

output voltage: DC5-27V  
output current: 0.01-2.5A  
DC: 5V2A/5V2.5A, 12V1A/12V1.2A/15V1A/24V0.625A  
product certificate: CB, UKCA(ROHS/REACH/ERP)

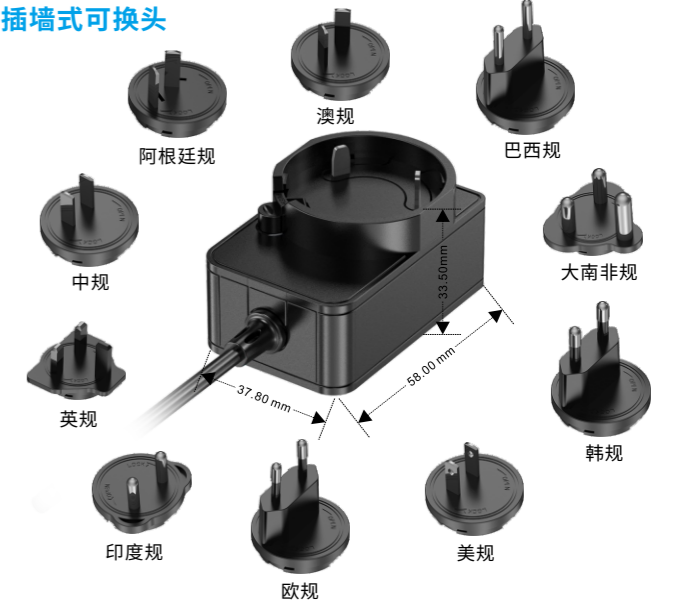

# 24W

**JHD** MORE+ www.jhdpower.com

DC/Lenovo/TYPE-C/MICRO

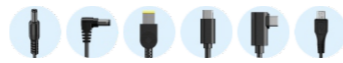

## CCC中规

**InputCharacteristics**  
Input voltage:100-240VAC  
Input frequency:47~63HZ  
efficiency:88%

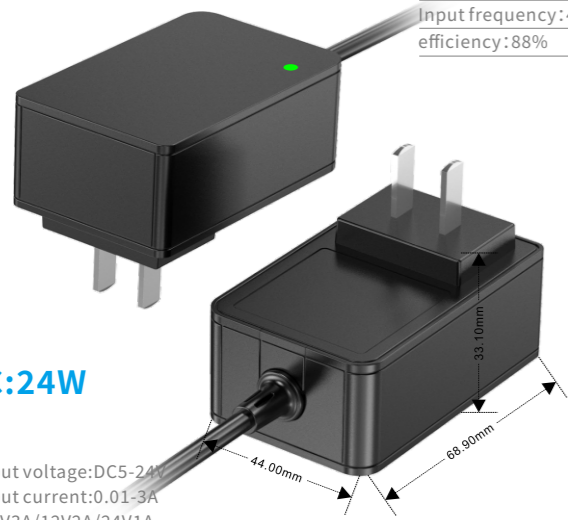

## DC:24W

output voltage:DC5-24V  
output current:0.01-3A  
DC:5V3A/12V2A/24V1A  
product certificate: CB, CCC(CECP)

## CE欧规/EAC俄罗斯

**InputCharacteristics**  
Input voltage:100-240VAC  
Input frequency:47~63HZ  
efficiency:88%

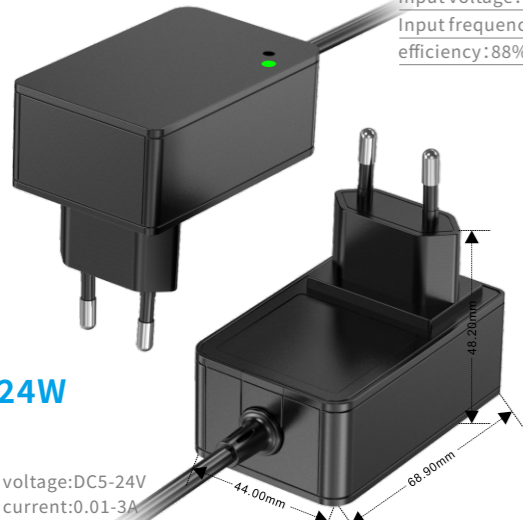

## DC:24W

output voltage:DC5-24V  
output current:0.01-3A  
DC:5V3A/12V2A/24V1A  
product certificate: CB, CE, EAC(ROHS/REACH/ICES/ERP)

## Kc韩国

**InputCharacteristics**  
Input voltage:100-240VAC  
Input frequency:47~63HZ  
efficiency:88%

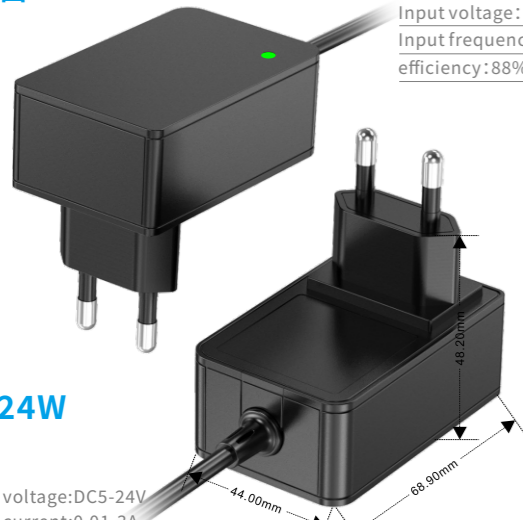

## DC:24W

output voltage:DC5-24V  
output current:0.01-3A  
DC:5V3A/12V2A/24V1A  
product certificate: CB, KC, KCC(MEPS/ROHS/REACH/ERP)

## UL美规/PSE日规 NOM墨西哥/BSMI台湾

**InputCharacteristics**  
Input voltage:100-240VAC  
Input frequency:47~63HZ  
efficiency:88%

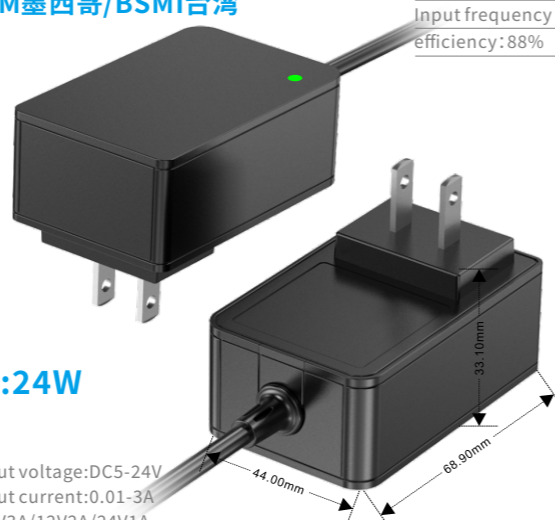

## DC:24W

output voltage:DC5-24V  
output current:0.01-3A  
DC:5V3A/12V2A/24V1A  
product certificate: CB, UL, FCC, PSE(ROHS/REACH/DOE/CEC/ICES)

## Br巴西规

**InputCharacteristics**  
Input voltage:100-240VAC  
Input frequency:47~63HZ  
efficiency:88%

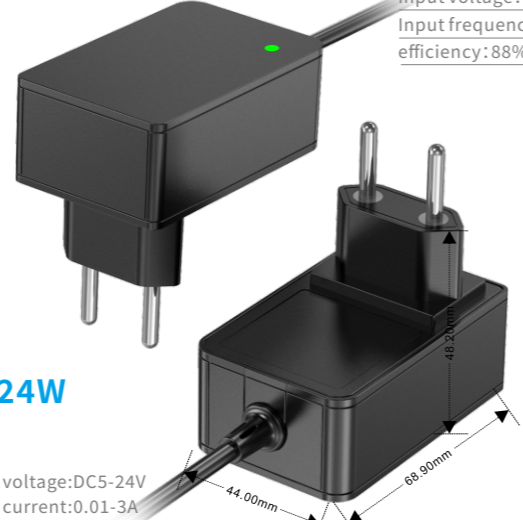

## DC:24W

output voltage:DC5-24V  
output current:0.01-3A  
DC:5V3A/12V2A/24V1A  
product certificate: CB, BR(ROHS/REACH/ICES/ERP)

## S-MARK阿根廷

**InputCharacteristics**  
Input voltage:100-240VAC  
Input frequency:47~63HZ  
efficiency:88%



## DC:24W

output voltage:DC5-24V  
output current:0.01-3A  
DC:5V3A/12V2A/24V1A  
product certificate: CB, S-MARK(ROHS/REACH/ERP)

# 24W

**JHD** MORE+ www.jhdpower.com

DC/Lenovo/TYPE-C/MICRO

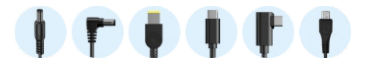

## SAA澳大利亚

**InputCharacteristics**  
Input voltage:100-240VAC  
Input frequency:47~63HZ  
efficiency:88%

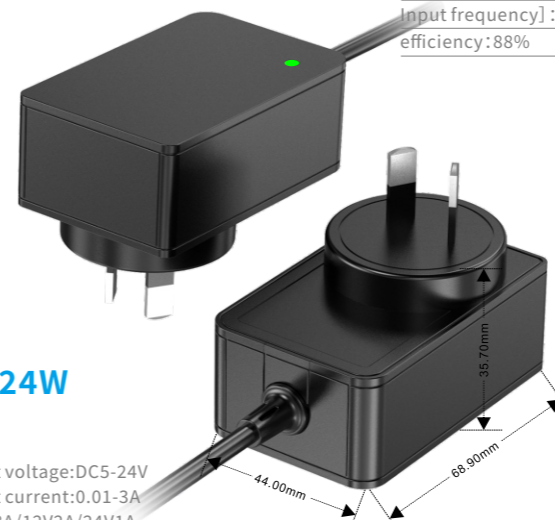

## DC:24W

output voltage:DC5-24V  
output current:0.01-3A  
DC:5V3A/12V2A/24V1A  
product certificate: SAA, C-tick (GEMS/ROHS/REACH/ERP)

## Bs英国

**InputCharacteristics**  
Input voltage:100-240VAC  
Input frequency:47~63HZ  
efficiency:88%

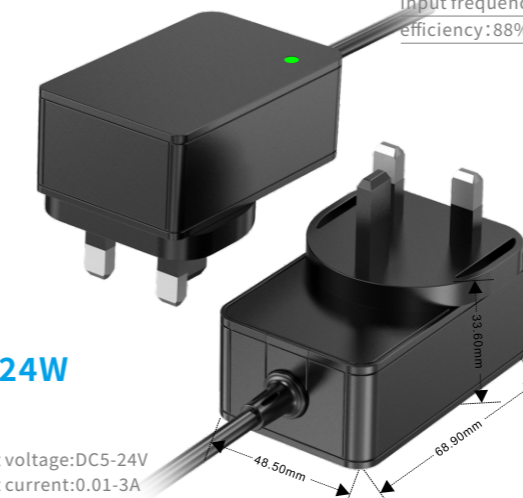

## DC:24W

output voltage:DC5-24V  
output current:0.01-3A  
DC:5V3A/12V2A/24V1A  
product certificate: CB, UKCA(ROHS/REACH/ERP)

## BIS印度规

**InputCharacteristics**  
Input voltage:100-240VAC  
Input frequency:47~63HZ  
efficiency:88%

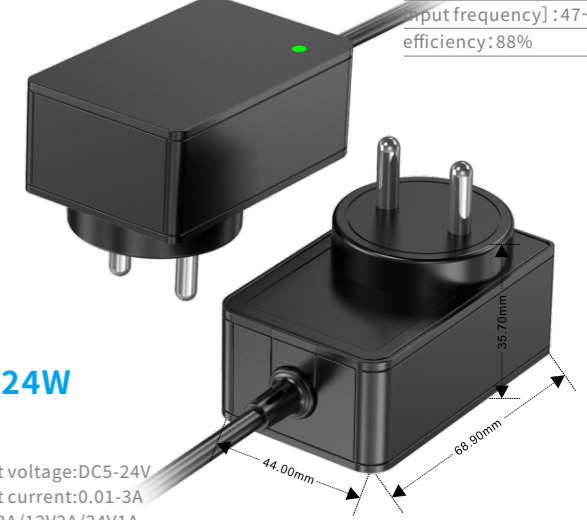

## DC:24W

output voltage:DC5-24V  
output current:0.01-3A  
DC:5V3A/12V2A/24V1A  
product certificate: CB, BIS(/ROHS/REACH/ERP)

## 插墙式可换头

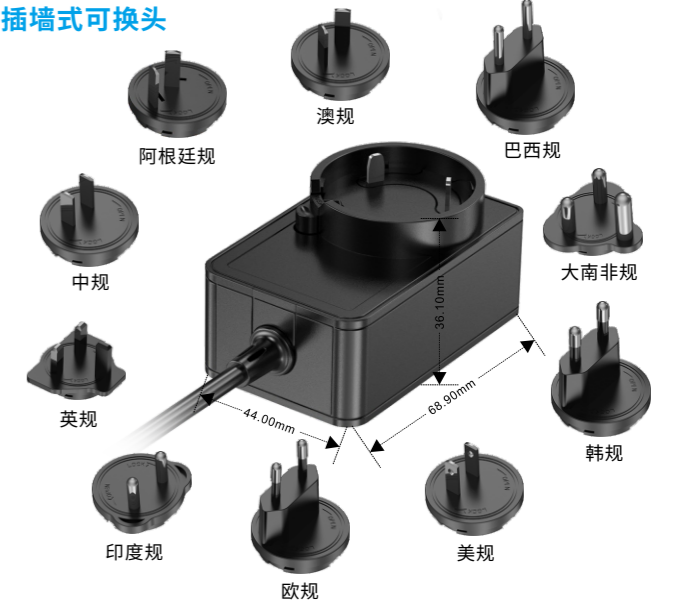

# 36W

**MORE+** www.jhdpower.com

DC/Lenovo/TYPER-C/MICRO



## CCC中規

**InputCharacteristics**  
Input voltage:100-240VAC  
Input frequency:47~63HZ  
efficiency:88%

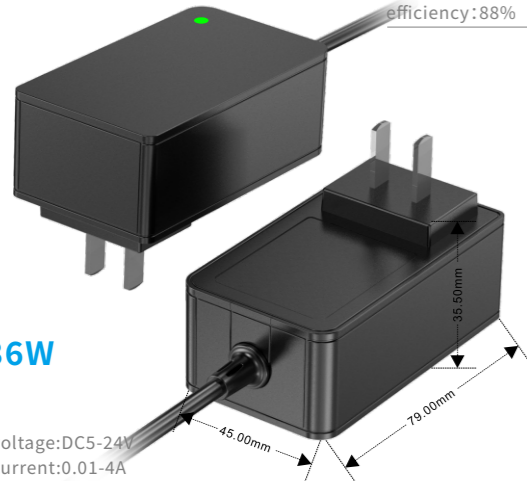

## DC:36W

output voltage:DC5-24V  
output current:0.01-4A  
DC:5V4A/12V3A.19V2.1A/24V1.5A  
product certificate: CB, CCC(CECP)

## CE歐規/EAC俄羅斯

**InputCharacteristics**  
Input voltage:100-240VAC  
Input frequency:47~63HZ  
efficiency:88%

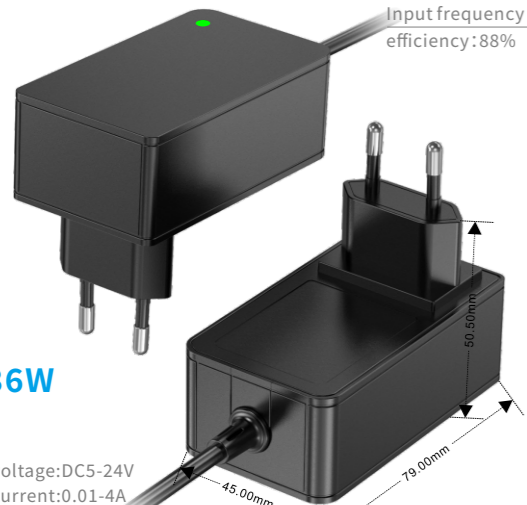

## DC:36W

output voltage:DC5-24V  
output current:0.01-4A  
DC:5V4A/12V3A.19V2.1A/24V1.5A  
product certificate: CB, CE, EAC(ROHS/REACH/ICES/ERP)

## Kc韓國

**InputCharacteristics**  
Input voltage:100-240VAC  
Input frequency:47~63HZ  
efficiency:88%

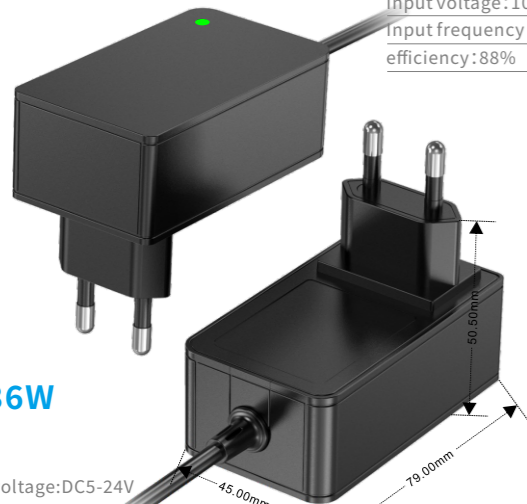

## DC:36W

output voltage:DC5-24V  
output current:0.01-4A  
DC:5V4A/12V3A.19V2.1A/24V1.5A  
product certificate: CB, KC, KCC(MEPS/ROHS/REACH/ERP)

## UL美規/PSE日規 NOM墨西哥/BSMI台灣

**InputCharacteristics**  
Input voltage:100-240VAC  
Input frequency:47~63HZ  
efficiency:88%

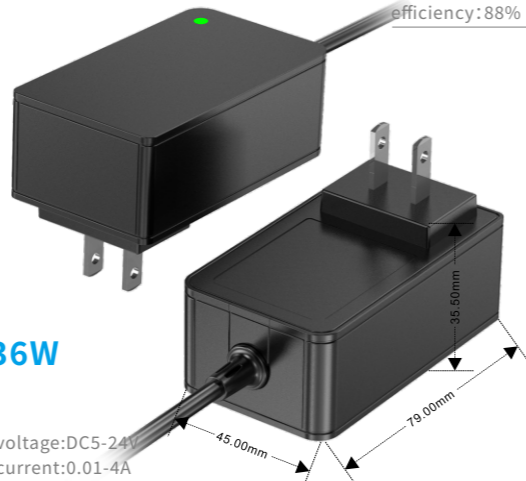

## DC:36W

output voltage:DC5-24V  
output current:0.01-4A  
DC:5V4A/12V3A.19V2.1A/24V1.5A  
product certificate: CB, UL, FCC, PSE(ROHS/REACH/DOE/CEC/ICES)

## Br巴西規

**InputCharacteristics**  
Input voltage:100-240VAC  
Input frequency:47~63HZ  
efficiency:88%

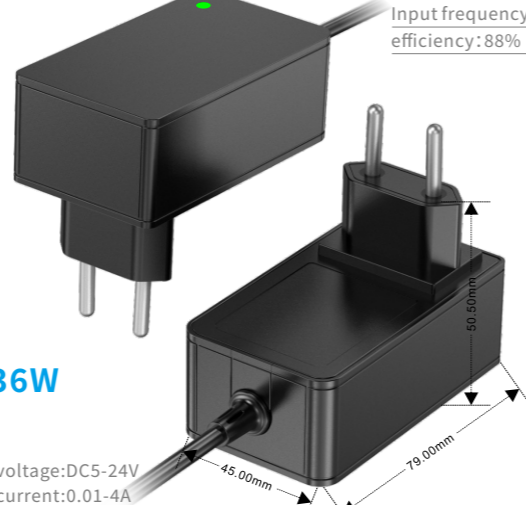

## DC:36W

output voltage:DC5-24V  
output current:0.01-4A  
DC:5V4A/12V3A.19V2.1A/24V1.5A  
product certificate: CB, BR(ROHS/REACH/ICES/ERP)

## S-MARK阿根廷

**InputCharacteristics**  
Input voltage:100-240VAC  
Input frequency:47~63HZ  
efficiency:88%

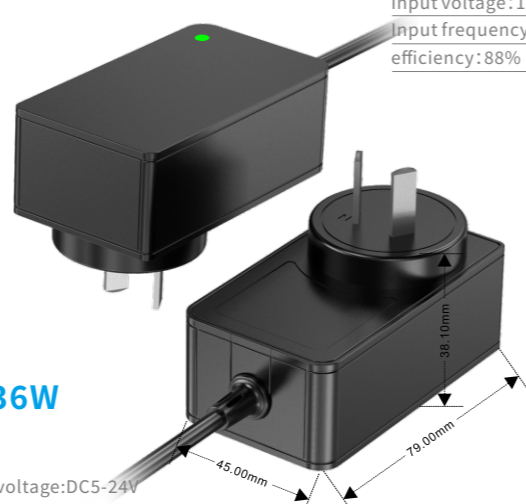

## DC:36W

output voltage:DC5-24V  
output current:0.01-4A  
DC:5V4A/12V3A.19V2.1A/24V1.5A  
product certificate: CB, S-MARK(ROHS/REACH/ERP)

# 36W

**MORE+** www.jhdpower.com

DC/Lenovo/TYPER-C/MICRO



## SAA澳大利亞

**InputCharacteristics**  
Input voltage:100-240VAC  
Input frequency:47~63HZ  
efficiency:88%

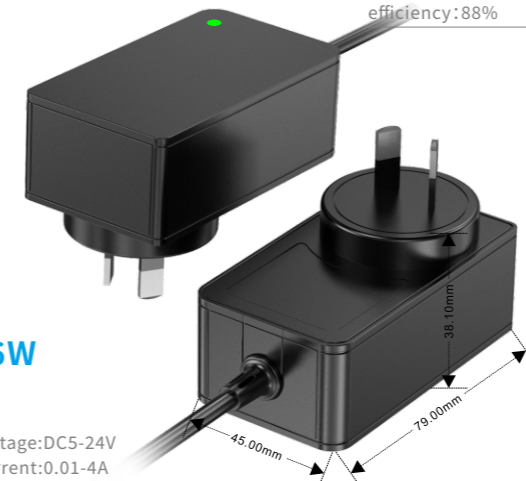

## DC:36W

output voltage:DC5-24V  
output current:0.01-4A  
DC:5V4A/12V3A.19V2.1A/24V1.5A  
product certificate: SAA, C-tick (GEMS/ROHS/REACH/ERP)

## Bs英國

**InputCharacteristics**  
Input voltage:100-240VAC  
Input frequency:47~63HZ  
efficiency:88%

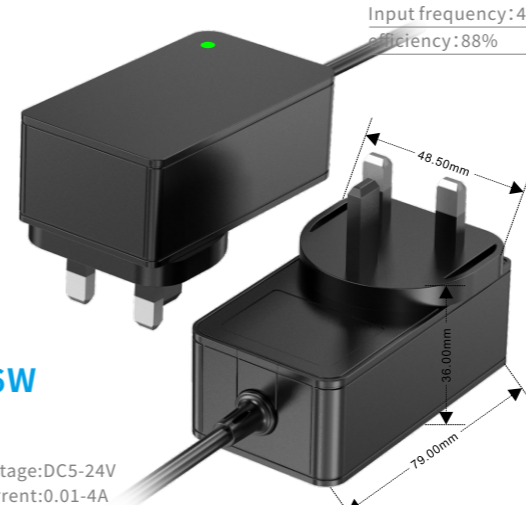

## DC:36W

output voltage:DC5-24V  
output current:0.01-4A  
DC:5V4A/12V3A.19V2.1A/24V1.5A  
product certificate: CB, UKCA(ROHS/REACH/ERP)

## BIS印度規

**InputCharacteristics**  
Input voltage:100-240VAC  
Input frequency:47~63HZ  
efficiency:88%

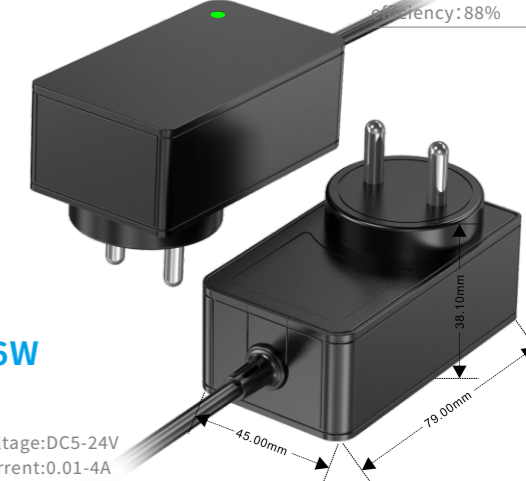

## DC:36W

output voltage:DC5-24V  
output current:0.01-4A  
DC:5V4A/12V3A.19V2.1A/24V1.5A  
product certificate: CB, BIS(/ROHS/REACH/ERP)

## 插牆式可換頭

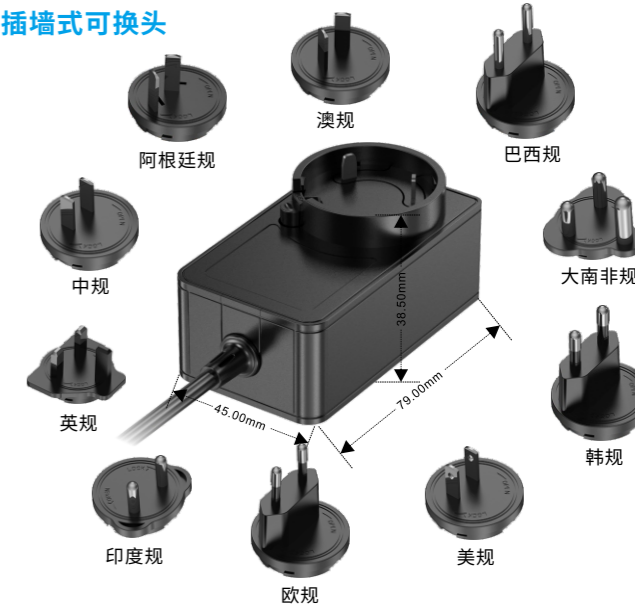

# 40W

JHD MORE+ www.jhdpower.com

DC/Lenovo/TYPE-C/MICRO



## CCC中规折叠插脚

Input Characteristics  
Input voltage: 100-240VAC  
Input frequency: 47-63HZ  
efficiency: 88%

## CCC中规固定插脚

Input Characteristics  
Input voltage: 100-240VAC  
Input frequency: 47-63HZ  
efficiency: 88%



### DC:40W

output voltage: DC9-24V  
output current: 0.1-3A  
DC: 9V3A/12V3A/19V2.1A/24V1.66A  
product certificate: CB, CCC (CECP)

### DC:40W

output voltage: DC9-24V  
output current: 0.1-3A  
DC: 9V3A/12V3A/19V2.1A/24V1.66A  
product certificate: CB, CCC (CECP)

## UL美规/PSE日规折叠插脚 NOM墨西哥/BSMI台湾折叠插脚

Input Characteristics  
Input voltage: 100-240VAC  
Input frequency: 47-63HZ  
efficiency: 88%

## UL美规/PSE日规固定插脚 NOM墨西哥/BSMI台湾固定插脚

Input Characteristics  
Input voltage: 100-240VAC  
Input frequency: 47-63HZ  
efficiency: 88%



### DC:40W

output voltage: DC9-24V  
output current: 0.1-3A  
DC: 9V3A/12V3A/19V2.1A/24V1.66A  
product certificate: CB, UL, FCC, PSE (ROHS/REACH/DOE/CEC/ICES)

### DC:40W

output voltage: DC9-24V  
output current: 0.1-3A  
DC: 9V3A/12V3A/19V2.1A/24V1.66A  
product certificate: CB, UL, FCC, PSE (ROHS/REACH/DOE/CEC/ICES)

## CE欧规/EAC俄罗斯

Input Characteristics  
Input voltage: 100-240VAC  
Input frequency: 47-63HZ  
efficiency: 88%

## Br巴西规

Input Characteristics  
Input voltage: 100-240VAC  
Input frequency: 47-63HZ  
efficiency: 88%



### DC:40W

output voltage: DC9-24V  
output current: 0.1-3A  
DC: 9V3A/12V3A/19V2.1A/24V1.66A  
product certificate: CB, CE, EAC (ROHS/REACH/ICES/ERP)

### DC:40W

output voltage: DC9-24V  
output current: 0.1-3A  
DC: 9V3A/12V3A/19V2.1A/24V1.66A  
product certificate: CB, BR (ROHS/REACH/ICES/ERP)

# 40W

JHD MORE+ www.jhdpower.com

DC/Lenovo/TYPE-C/MICRO

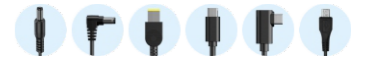

## Kc韩国

Input Characteristics  
Input voltage: 100-240VAC  
Input frequency: 47-63HZ  
efficiency: 88%

## S-MARK阿根廷

Input Characteristics  
Input voltage: 100-240VAC  
Input frequency: 47-63HZ  
efficiency: 88%

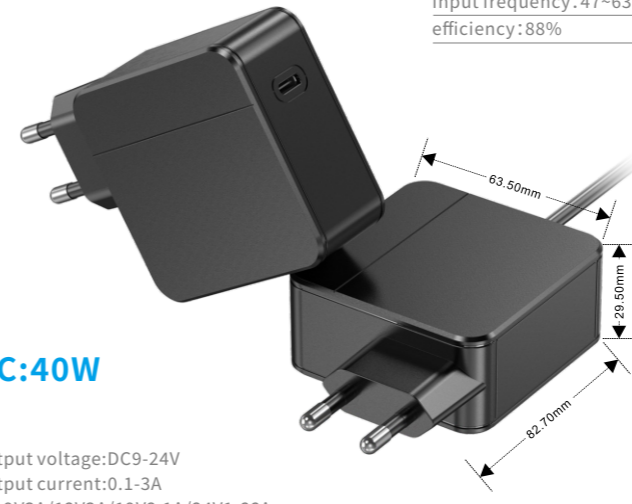

### DC:40W

output voltage: DC9-24V  
output current: 0.1-3A  
DC: 9V3A/12V3A/19V2.1A/24V1.66A  
product certificate: CB, KC, KCC (MEPS/ROHS/REACH/ERP)

### DC:40W

output voltage: DC9-24V  
output current: 0.1-3A  
DC: 9V3A/12V3A/19V2.1A/24V1.66A  
product certificate: CB, S-MARK (ROHS/REACH/ERP)

## SAA澳大利亚

Input Characteristics  
Input voltage: 100-240VAC  
Input frequency: 47-63HZ  
efficiency: 88%

## BIS印度规

Input Characteristics  
Input voltage: 100-240VAC  
Input frequency: 47-63HZ  
efficiency: 88%

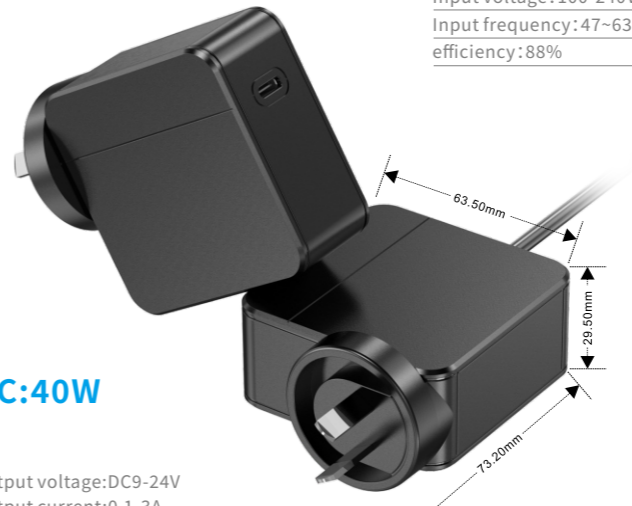

### DC:40W

output voltage: DC9-24V  
output current: 0.1-3A  
DC: 9V3A/12V3A/19V2.1A/24V1.66A  
product certificate: SAA, C-tick (GEMS/ROHS/REACH/ERP)

### DC:40W

output voltage: DC9-24V  
output current: 0.1-3A  
DC: 9V3A/12V3A/19V2.1A/24V1.66A  
product certificate: CB, BIS (ROHS/REACH/ERP)

## Bs英国

Input Characteristics  
Input voltage: 100-240VAC  
Input frequency: 47-63HZ  
efficiency: 88%

## C8桌面式

Input Characteristics  
Input voltage: 100-240VAC  
Input frequency: 47-63HZ  
efficiency: 88%

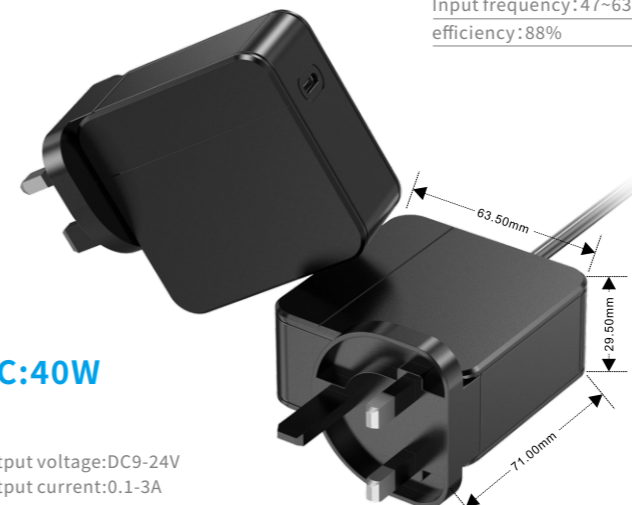

### DC:40W

output voltage: DC9-24V  
output current: 0.1-3A  
DC: 9V3A/12V3A/19V2.1A/24V1.66A  
product certificate: CB, UKCA (ROHS/REACH/ERP)

### DC:40W

output voltage: DC9-24V  
output current: 0.1-3A  
DC: 9V3A/12V3A/19V2.1A/24V1.66A  
product certificate: CCC/UL/FCC/PSE/KC/KCC/CE/UKCA/EAC/BIS/SAA/S-MARK BR (CECP/MEPS/DOE/CEC/ICES/GEMS/ERP/ROHS/REACH)

# 35W GaN方案

**JHD MORE+** www.jhdpower.com



## CCC中规折叠插脚

**Input Characteristics**  
Input voltage: 100-240VAC  
Input frequency: 47-63HZ  
efficiency: 92%

## CCC中规固定插脚

**Input Characteristics**  
Input voltage: 100-240VAC  
Input frequency: 47-63HZ  
efficiency: 92%

### PD:30W/36W & DC:36W

output voltage: DC5-24V  
output current: 0.1-3A  
PD3.0/MTK/FCP/AFC/APPLE/SCP/QC4.0/QC3.0/QC2.0/PPS  
product certificate: CB, CCC(CECP)

### UL美/PSE日规折叠插脚 NOM墨西哥/BSMI台湾折叠插脚

**Input Characteristics**  
Input voltage: 100-240VAC  
Input frequency: 47-63HZ  
efficiency: 92%

### PD:30W/36W & DC:36W

output voltage: DC5-24V  
output current: 0.1-3A  
PD3.0/MTK/FCP/AFC/APPLE/SCP/QC4.0/QC3.0/QC2.0/PPS  
product certificate: CB, UL, FCC, PSE(ROHS/REACH/DOE/CEC/ICES)

### CE欧规/EAC俄罗斯

**Input Characteristics**  
Input voltage: 100-240VAC  
Input frequency: 47-63HZ  
efficiency: 92%

### PD:30W/36W & DC:36W

output voltage: DC5-24V  
output current: 0.1-3A  
PD3.0/MTK/FCP/AFC/APPLE/SCP/QC4.0/QC3.0/QC2.0/PPS  
product certificate: CB, CE, EAC(ROHS/REACH/ICES/ERP)

深圳市吉宏达电子有限公司

### PD:30W/36W & DC:36W

output voltage: DC5-24V  
output current: 0.1-3A  
PD3.0/MTK/FCP/AFC/APPLE/SCP/QC4.0/QC3.0/QC2.0/PPS  
product certificate: CB, CCC(CECP)

### UL美规/PSE日规固定插脚 NOM墨西哥/BSMI台湾固定插脚

**Input Characteristics**  
Input voltage: 100-240VAC  
Input frequency: 47-63HZ  
efficiency: 92%

### PD:30W/36W & DC:36W

output voltage: DC5-24V  
output current: 0.1-3A  
PD3.0/MTK/FCP/AFC/APPLE/SCP/QC4.0/QC3.0/QC2.0/PPS  
product certificate: CB, UL, FCC, PSE(ROHS/REACH/DOE/CEC/ICES)

### Br巴西规

**Input Characteristics**  
Input voltage: 100-240VAC  
Input frequency: 47-63HZ  
efficiency: 92%

### PD:30W/36W & DC:36W

output voltage: DC5-24V  
output current: 0.1-3A  
PD3.0/MTK/FCP/AFC/APPLE/SCP/QC4.0/QC3.0/QC2.0/PPS  
product certificate: CB, BR(ROHS/REACH/ICES/ERP)

SHENZHENSHI JIHONGDA POWER. CO. LTD.

# 35W GaN方案

**JHD MORE+** www.jhdpower.com



## Kc韩国

**Input Characteristics**  
Input voltage: 100-240VAC  
Input frequency: 47-63HZ  
efficiency: 92%

### PD:30W/36W & DC:36W

output voltage: DC5-24V  
output current: 0.1-3A  
PD3.0/MTK/FCP/AFC/APPLE/SCP/QC4.0/QC3.0/QC2.0/PPS  
product certificate: CB, KC, KCC(MEPS/ROHS/REACH/ERP)

### SAA澳大利亚

**Input Characteristics**  
Input voltage: 100-240VAC  
Input frequency: 47-63HZ  
efficiency: 92%

### PD:30W/36W & DC:36W

output voltage: DC5-24V  
output current: 0.1-3A  
PD3.0/MTK/FCP/AFC/APPLE/SCP/QC4.0/QC3.0/QC2.0/PPS  
product certificate: SAA, C-tick(GEMS/ROHS/REACH/ERP)

### Bs英国

**Input Characteristics**  
Input voltage: 100-240VAC  
Input frequency: 47-63HZ  
efficiency: 92%

### PD:30W/36W & DC:36W

output voltage: DC5-24V  
output current: 0.1-3A  
PD3.0/MTK/FCP/AFC/APPLE/SCP/QC4.0/QC3.0/QC2.0/PPS  
product certificate: CB, UKCA(ROHS/REACH/ERP)

深圳市吉宏达电子有限公司

## S-MARK阿根廷

**Input Characteristics**  
Input voltage: 100-240VAC  
Input frequency: 47-63HZ  
efficiency: 92%

### PD:30W/36W & DC:36W

output voltage: DC5-24V  
output current: 0.1-3A  
PD3.0/MTK/FCP/AFC/APPLE/SCP/QC4.0/QC3.0/QC2.0/PPS  
product certificate: CB, S-MARK(ROHS/REACH/ERP)

### BIS印度规

**Input Characteristics**  
Input voltage: 100-240VAC  
Input frequency: 47-63HZ  
efficiency: 92%

### PD:30W/36W & DC:36W

output voltage: DC5-24V  
output current: 0.1-3A  
PD3.0/MTK/FCP/AFC/APPLE/SCP/QC4.0/QC3.0/QC2.0/PPS  
product certificate: CB, BIS(/ROHS/REACH/ERP)

### C8桌面式

**Input Characteristics**  
Input voltage: 100-240VAC  
Input frequency: 47-63HZ  
efficiency: 92%

### PD:30W/36W & DC:36W

output voltage: DC5-24V  
output current: 0.1-3A  
PD3.0/MTK/FCP/AFC/APPLE/SCP/QC4.0/QC3.0/QC2.0/PPS  
product certificate: CCC\UL\FCC\PSE\KC\KCC\CE\UKCA\EAC\BIS\SAA\S-MARK BR(CECP/MEPS//DOE/CEC/ICES/GEMS/ERP/ROHS/REACH)

SHENZHENSHI JIHONGDA POWER. CO. LTD.

# 45W GaN方案

**JHD MORE+** www.jhdpower.com



## CCC中规折叠插脚

**Input Characteristics**  
Input voltage: 100-240VAC  
Input frequency: 47-63HZ  
efficiency: 92%

## CCC中规固定插脚

**Input Characteristics**  
Input voltage: 100-240VAC  
Input frequency: 47-63HZ  
efficiency: 92%

### PD:45W & DC:48W

output voltage: DC5-24V  
output current: 0.1-4A  
PD3.0/MTK/FCP/AFC/APPLE/SCP/QC4.0/QC3.0/QC2.0/PPS  
product certificate: CB, CCC(CECP)

### UL美规/PSE日规折叠插脚 NOM墨西哥/BSMI台湾折叠插脚

**Input Characteristics**  
Input voltage: 100-240VAC  
Input frequency: 47-63HZ  
efficiency: 92%

### PD:45W & DC:48W

output voltage: DC5-24V  
output current: 0.1-4A  
PD3.0/MTK/FCP/AFC/APPLE/SCP/QC4.0/QC3.0/QC2.0/PPS  
product certificate: CB, UL, FCC, PSE(ROHS/REACH/DOE/CEC/ICES)

### CE欧规/EAC俄罗斯

**Input Characteristics**  
Input voltage: 100-240VAC  
Input frequency: 47-63HZ  
efficiency: 92%

### PD:45W & DC:48W

output voltage: DC5-24V  
output current: 0.1-4A  
PD3.0/MTK/FCP/AFC/APPLE/SCP/QC4.0/QC3.0/QC2.0/PPS  
product certificate: CB, CE, EAC(ROHS/REACH/ICES/ERP)

深圳市吉宏达电子有限公司

### PD:45W & DC:48W

output voltage: DC5-24V  
output current: 0.1-4A  
PD3.0/MTK/FCP/AFC/APPLE/SCP/QC4.0/QC3.0/QC2.0/PPS  
product certificate: CB, CCC(CECP)

### UL美规/PSE日规固定插脚 NOM墨西哥/BSMI台湾固定插脚

**Input Characteristics**  
Input voltage: 100-240VAC  
Input frequency: 47-63HZ  
efficiency: 92%

### PD:45W & DC:48W

output voltage: DC5-24V  
output current: 0.1-4A  
PD3.0/MTK/FCP/AFC/APPLE/SCP/QC4.0/QC3.0/QC2.0/PPS  
product certificate: CB, UL, FCC, PSE(ROHS/REACH/DOE/CEC/ICES)

### Br巴西规

**Input Characteristics**  
Input voltage: 100-240VAC  
Input frequency: 47-63HZ  
efficiency: 92%

### PD:45W & DC:48W

output voltage: DC5-24V  
output current: 0.1-4A  
PD3.0/MTK/FCP/AFC/APPLE/SCP/QC4.0/QC3.0/QC2.0/PPS  
product certificate: CB, BR(ROHS/REACH/ICES/ERP)

SHENZHENSHI JIHONGDA POWER. CO. LTD.

# 45W GaN方案

**JHD MORE+** www.jhdpower.com



## Kc韩国

**Input Characteristics**  
Input voltage: 100-240VAC  
Input frequency: 47-63HZ  
efficiency: 92%

### PD:45W & DC:48W

output voltage: DC5-24V  
output current: 0.1-4A  
PD3.0/MTK/FCP/AFC/APPLE/SCP/QC4.0/QC3.0/QC2.0/PPS  
product certificate: CB, KC, KCC(MEPS/ROHS/REACH/ERP)

### SAA澳大利亚

**Input Characteristics**  
Input voltage: 100-240VAC  
Input frequency: 47-63HZ  
efficiency: 92%

### PD:45W & DC:48W

output voltage: DC5-24V  
output current: 0.1-4A  
PD3.0/MTK/FCP/AFC/APPLE/SCP/QC4.0/QC3.0/QC2.0/PPS  
product certificate: SAA, C-tick (GEMS/ROHS/REACH/ERP)

### Bs英国

**Input Characteristics**  
Input voltage: 100-240VAC  
Input frequency: 47-63HZ  
efficiency: 92%

### PD:45W & DC:48W

output voltage: DC5-24V  
output current: 0.1-4A  
PD3.0/MTK/FCP/AFC/APPLE/SCP/QC4.0/QC3.0/QC2.0/PPS  
product certificate: CB, UKCA(ROHS/REACH/ERP)

深圳市吉宏达电子有限公司

## S-MARK阿根廷

**Input Characteristics**  
Input voltage: 100-240VAC  
Input frequency: 47-63HZ  
efficiency: 92%

### PD:45W & DC:48W

output voltage: DC5-24V  
output current: 0.1-4A  
PD3.0/MTK/FCP/AFC/APPLE/SCP/QC4.0/QC3.0/QC2.0/PPS  
product certificate: CB, S-MARK(ROHS/REACH/ERP)

### BIS印度规

**Input Characteristics**  
Input voltage: 100-240VAC  
Input frequency: 47-63HZ  
efficiency: 92%

### PD:45W & DC:48W

output voltage: DC5-24V  
output current: 0.1-4A  
PD3.0/MTK/FCP/AFC/APPLE/SCP/QC4.0/QC3.0/QC2.0/PPS  
product certificate: CB, BIS(/ROHS/REACH/ERP)

### C8桌面式

**Input Characteristics**  
Input voltage: 100-240VAC  
Input frequency: 47-63HZ  
efficiency: 92%

### PD:45W & DC:48W

output voltage: DC5-24V  
output current: 0.1-4A  
PD3.0/MTK/FCP/AFC/APPLE/SCP/QC4.0/QC3.0/QC2.0/PPS  
product certificate: CCC/UL/FCC/PSE/KC/KCC/CE/UKCA/EAC/BIS/SAA/S-MARK BR (CECP/MEPS//DOE/CEC/ICES/GEMS/ERP/ROHS/REACH)

SHENZHENSHI JIHONGDA POWER. CO. LTD.



# 65W GaN方案

**JHD MORE+** www.jhdpower.com



## CCC中规折叠插脚

**Input Characteristics**  
Input voltage: 100-240VAC  
Input frequency: 47-63HZ  
efficiency: 92%

## CCC中规固定插脚

**Input Characteristics**  
Input voltage: 100-240VAC  
Input frequency: 47-63HZ  
efficiency: 92%

### PD:65W & DC:65W

output voltage: DC5-24V  
output current: 0.1-5A  
PD3.0/MTK/FCP/AFC/APPLE/SCP/QC4.0/QC3.0/QC2.0/PPS  
product certificate: CB, CCC(CECP)

### UL美/PSE日规折叠插脚 NOM墨西哥/BSMI台湾折叠插脚

**Input Characteristics**  
Input voltage: 100-240VAC  
Input frequency: 47-63HZ  
efficiency: 92%

### UL美规/PSE日规固定插脚 NOM墨西哥/BSMI台湾固定插脚

**Input Characteristics**  
Input voltage: 100-240VAC  
Input frequency: 47-63HZ  
efficiency: 92%

### PD:65W & DC:65W

output voltage: DC5-24V  
output current: 0.1-5A  
PD3.0/MTK/FCP/AFC/APPLE/SCP/QC4.0/QC3.0/QC2.0/PPS  
product certificate: CB, UL, FCC, PSE(ROHS/REACH/DOE/CEC/ICES)

### CE欧规/EAC俄罗斯

**Input Characteristics**  
Input voltage: 100-240VAC  
Input frequency: 47-63HZ  
efficiency: 92%

### Br巴西规

**Input Characteristics**  
Input voltage: 100-240VAC  
Input frequency: 47-63HZ  
efficiency: 92%

### PD:65W & DC:65W

output voltage: DC5-24V  
output current: 0.1-5A  
PD3.0/MTK/FCP/AFC/APPLE/SCP/QC4.0/QC3.0/QC2.0/PPS  
product certificate: CB, CE, EAC(ROHS/REACH/ICES/ERP)

### PD:65W & DC:65W

output voltage: DC5-24V  
output current: 0.1-5A  
PD3.0/MTK/FCP/AFC/APPLE/SCP/QC4.0/QC3.0/QC2.0/PPS  
product certificate: CB, BR(ROHS/REACH/ICES/ERP)

# 65W GaN方案

**JHD MORE+** www.jhdpower.com



## Kc韩国

**Input Characteristics**  
Input voltage: 100-240VAC  
Input frequency: 47-63HZ  
efficiency: 92%

## S-MARK阿根廷

**Input Characteristics**  
Input voltage: 100-240VAC  
Input frequency: 47-63HZ  
efficiency: 92%

### PD:65W & DC:65W

output voltage: DC5-24V  
output current: 0.1-5A  
PD3.0/MTK/FCP/AFC/APPLE/SCP/QC4.0/QC3.0/QC2.0/PPS  
product certificate: CB, KC, KCC(MEPS/ROHS/REACH/ERP)

### SAA澳大利亚

**Input Characteristics**  
Input voltage: 100-240VAC  
Input frequency: 47-63HZ  
efficiency: 92%

### BIS印度规

**Input Characteristics**  
Input voltage: 100-240VAC  
Input frequency: 47-63HZ  
efficiency: 92%

### PD:65W & DC:65W

output voltage: DC5-24V  
output current: 0.1-5A  
PD3.0/MTK/FCP/AFC/APPLE/SCP/QC4.0/QC3.0/QC2.0/PPS  
product certificate: SAA, C-tick (GEMS/ROHS/REACH/ERP)

### Bs英国

**Input Characteristics**  
Input voltage: 100-240VAC  
Input frequency: 47-63HZ  
efficiency: 92%

### C8桌面式

**Input Characteristics**  
Input voltage: 100-240VAC  
Input frequency: 47-63HZ  
efficiency: 92%

### PD:65W & DC:65W

output voltage: DC5-24V  
output current: 0.1-5A  
PD3.0/MTK/FCP/AFC/APPLE/SCP/QC4.0/QC3.0/QC2.0/PPS  
product certificate: CB, UKCA(ROHS/REACH/ERP)

### PD:65W & DC:65W

output voltage: DC5-24V  
output current: 0.1-5A  
PD3.0/MTK/FCP/AFC/APPLE/SCP/QC4.0/QC3.0/QC2.0/PPS  
product certificate: CCC\UL\FCC\PSE\KC\KCC\CE\UKCA\EAC\BIS\SAA\S-MARK BR (CECP/MEPS//DOE/CEC/ICES/GEMS/ERP/ROHS/REACH)

# 65W GaN方案

**JHD MORE+** www.jhdpower.com

DC/Lenovo/TYPER-C/MICRO



## C6桌面式

**InputCharacteristics**  
Input voltage:100-240VAC  
Input frequency:47~63HZ  
efficiency:92%

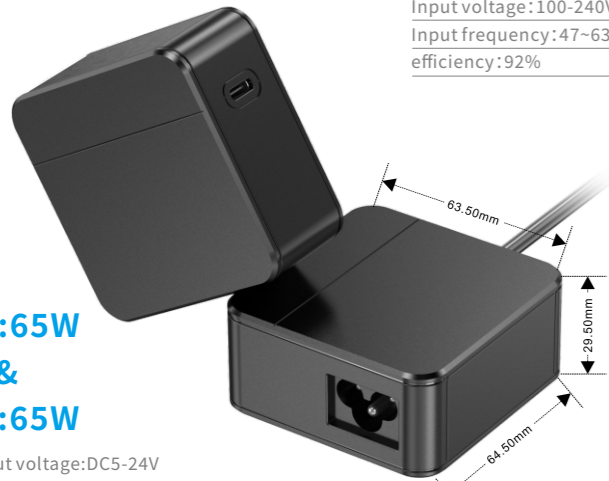

**PD:65W & DC:65W**

output voltage:DC5-24V  
output current:0.1-5A  
PD3.0/MTK/FCP/AFC/APPLE/SCP/QC4.0/QC3.0/QC2.0/PPS  
product certificate: CCC\UL\FCC\PSE\KC\KCC\CE\UKCA\EAC\BIS\SAA\S-MARK BR (CECP/MEPS//DOE/CEC/ICES/GEMS/ERP/ROHS/REACH)

## CE欧规直插式

**InputCharacteristics**  
Input voltage:100-240VAC  
Input frequency:47~63HZ  
efficiency:92%

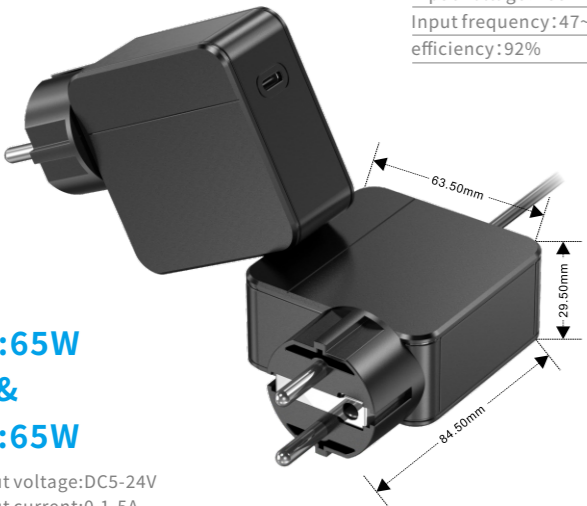

**PD:65W & DC:65W**

output voltage:DC5-24V  
output current:0.1-5A  
PD3.0/MTK/FCP/AFC/APPLE/SCP/QC4.0/QC3.0/QC2.0/PPS  
product certificate: CB, CE, EAC(ROHS/REACH/ICES/ERP)

## CCC中规直插式

**InputCharacteristics**  
Input voltage:100-240VAC  
Input frequency:47~63HZ  
efficiency:92%

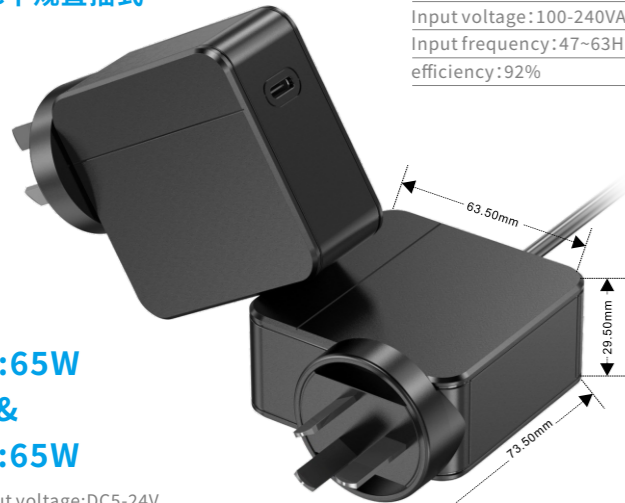

**PD:65W & DC:65W**

output voltage:DC5-24V  
output current:0.1-5A  
PD3.0/MTK/FCP/AFC/APPLE/SCP/QC4.0/QC3.0/QC2.0/PPS  
product certificate: CB, CCC(CECP)

## C14桌面式

**InputCharacteristics**  
Input voltage:100-240VAC  
Input frequency:47~63HZ  
efficiency:92%

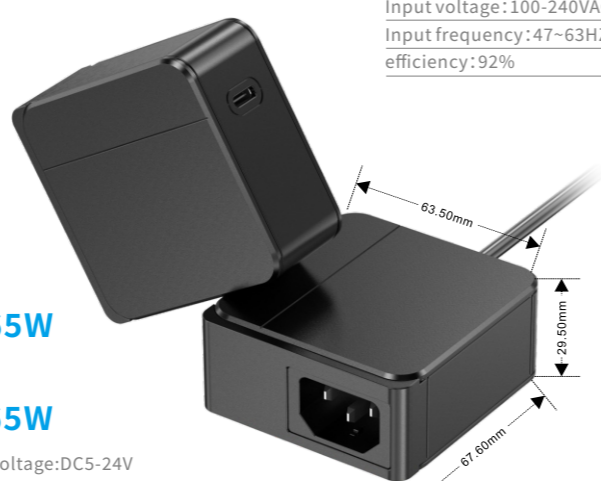

**PD:65W & DC:65W**

output voltage:DC5-24V  
output current:0.1-5A  
PD3.0/MTK/FCP/AFC/APPLE/SCP/QC4.0/QC3.0/QC2.0/PPS  
product certificate: CCC\UL\FCC\PSE\KC\KCC\CE\UKCA\EAC\BIS\SAA\S-MARK BR (CECP/MEPS//DOE/CEC/ICES/GEMS/ERP/ROHS/REACH)

## UL美规/PSE日规直插式

**InputCharacteristics**  
Input voltage:100-240VAC  
Input frequency:47~63HZ  
efficiency:92%

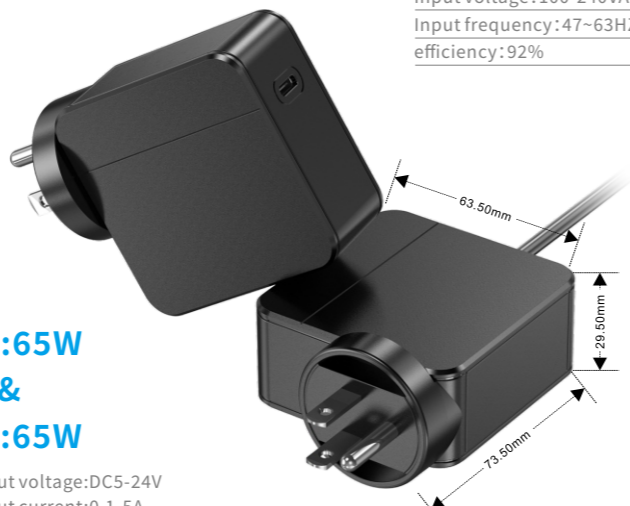

**PD:65W & DC:65W**

output voltage:DC5-24V  
output current:0.1-5A  
PD3.0/MTK/FCP/AFC/APPLE/SCP/QC4.0/QC3.0/QC2.0/PPS  
product certificate: CB, UL, FCC, PSE(ROHS/REACH/DOE/CEC/ICES)

## S-MARK阿根廷规直插式

**InputCharacteristics**  
Input voltage:100-240VAC  
Input frequency:47~63HZ  
efficiency:92%

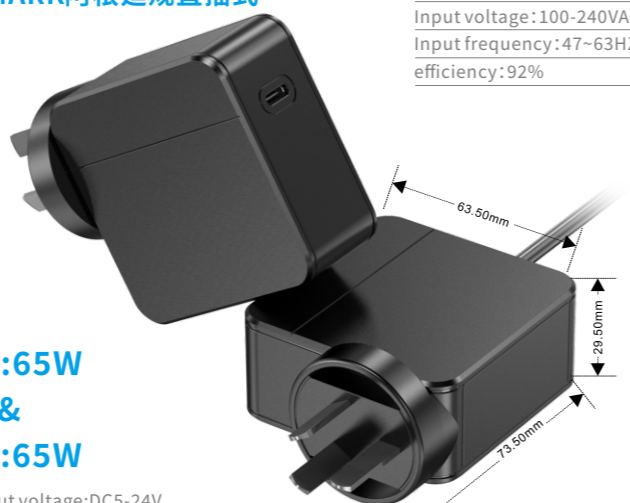

**PD:65W & DC:65W**

output voltage:DC5-24V  
output current:0.1-5A  
PD3.0/MTK/FCP/AFC/APPLE/SCP/QC4.0/QC3.0/QC2.0/PPS  
product certificate: CB, S-MARK(ROHS/REACH/ERP)

# 65W GaN方案

**JHD MORE+** www.jhdpower.com

DC/Lenovo/TYPER-C/MICRO

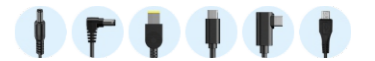

## SAA澳规直插式

**InputCharacteristics**  
Input voltage:100-240VAC  
Input frequency:47~63HZ  
efficiency:92%

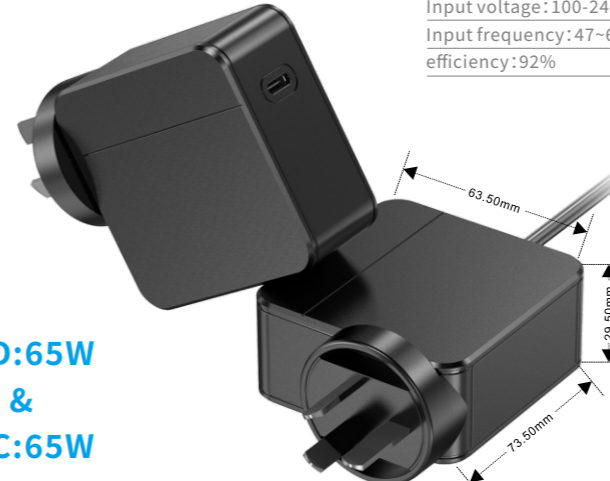

**PD:65W & DC:65W**

output voltage:DC5-24V  
output current:0.1-5A  
PD3.0/MTK/FCP/AFC/APPLE/SCP/QC4.0/QC3.0/QC2.0/PPS  
product certificate: SAA, C-tick (GEMS/ROHS/REACH/ERP)

## 35W/45W 插墙式可换头

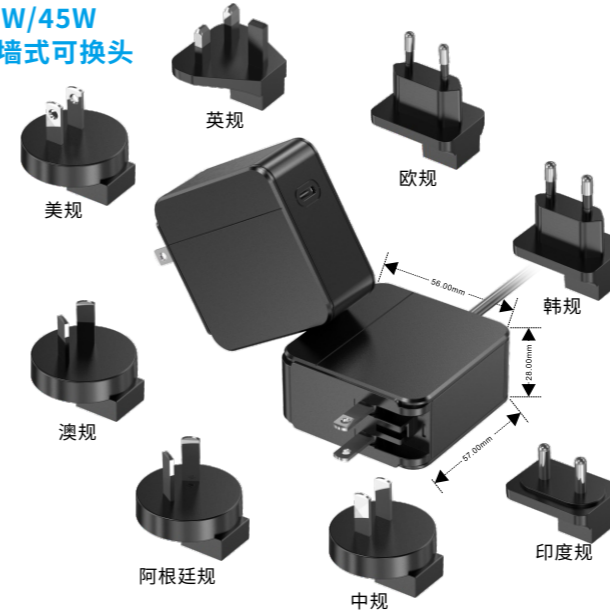

## 40W/65W 插墙式可换头

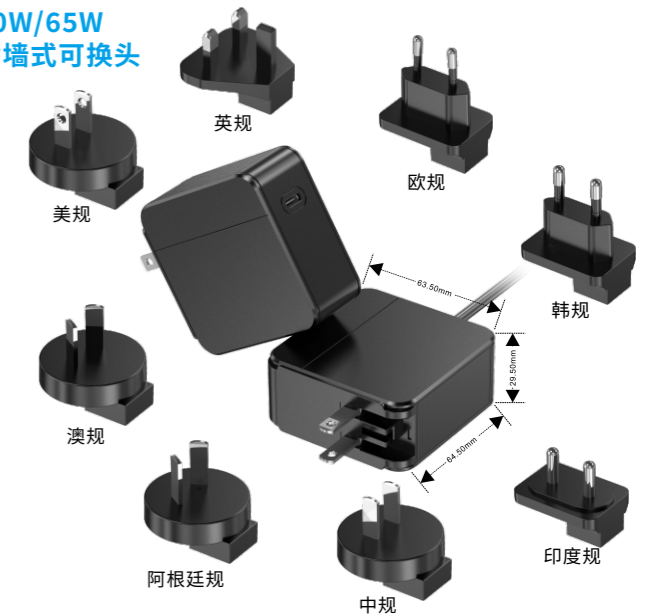

# 100W GaN方案

**JHD MORE+** www.jhdpower.com



## CCC中规折叠插脚

**InputCharacteristics**  
Input voltage:100-240VAC  
Input frequency:47~63HZ  
efficiency:93%



**PD:100W  
&  
DC:120W**

output voltage:DC5-24V  
output current:0.1-8A  
PD3.0/MTK/FCP/AFC/APPLE/SCP/QC4.0/QC3.0/QC2.0/PPS  
product certificate: CB, CCC(CECP)

## UL美/PSE日规折叠插脚 NOM墨西哥/BSMI台湾折叠插脚

**InputCharacteristics**  
Input voltage:100-240VAC  
Input frequency:47~63HZ  
efficiency:93%



**PD:100W  
&  
DC:120W**

output voltage:DC5-24V  
output current:0.1-8A  
PD3.0/MTK/FCP/AFC/APPLE/SCP/QC4.0/QC3.0/QC2.0/PPS  
product certificate: CB, UL, FCC, PSE(ROHS/REACH/DOE/CEC/ICES)

## CE欧规/EAC俄罗斯

**InputCharacteristics**  
Input voltage:100-240VAC  
Input frequency:47~63HZ  
efficiency:93%

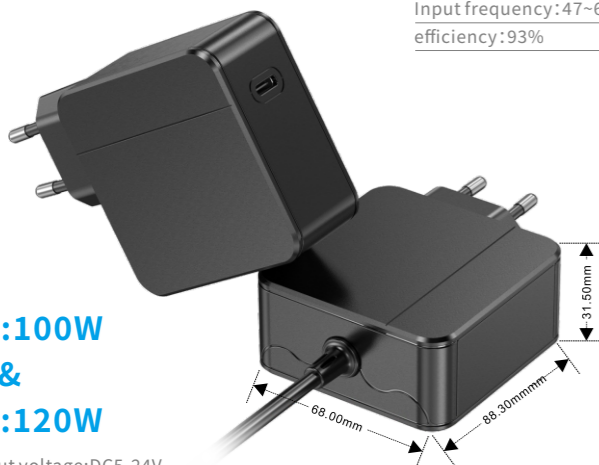

**PD:100W  
&  
DC:120W**

output voltage:DC5-24V  
output current:0.1-8A  
PD3.0/MTK/FCP/AFC/APPLE/SCP/QC4.0/QC3.0/QC2.0/PPS  
product certificate: CB, CE, EAC(ROHS/REACH/ICES/ERP)

深圳市吉宏达电子有限公司

## CCC中规固定插脚

**InputCharacteristics**  
Input voltage:100-240VAC  
Input frequency:47~63HZ  
efficiency:93%

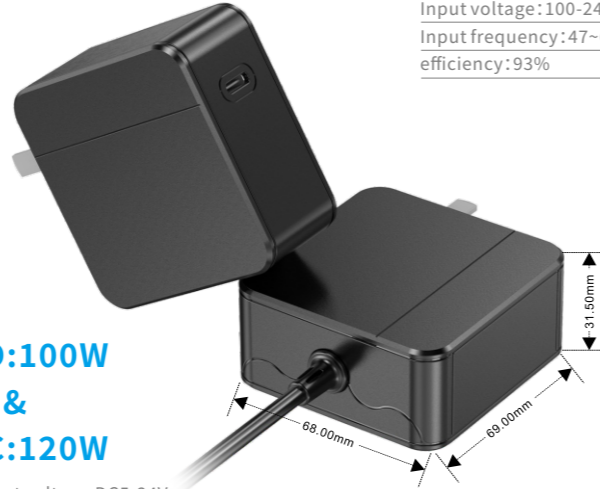

**PD:100W  
&  
DC:120W**

output voltage:DC5-24V  
output current:0.1-8A  
PD3.0/MTK/FCP/AFC/APPLE/SCP/QC4.0/QC3.0/QC2.0/PPS  
product certificate: CB, CCC(CECP)

## UL美/PSE日规固定插脚 NOM墨西哥/BSMI台湾固定插脚

**InputCharacteristics**  
Input voltage:100-240VAC  
Input frequency:47~63HZ  
efficiency:93%



**PD:100W  
&  
DC:120W**

output voltage:DC5-24V  
output current:0.1-8A  
PD3.0/MTK/FCP/AFC/APPLE/SCP/QC4.0/QC3.0/QC2.0/PPS  
product certificate: CB, UL, FCC, PSE(ROHS/REACH/DOE/CEC/ICES)

## Br巴西规

**InputCharacteristics**  
Input voltage:100-240VAC  
Input frequency:47~63HZ  
efficiency:93%

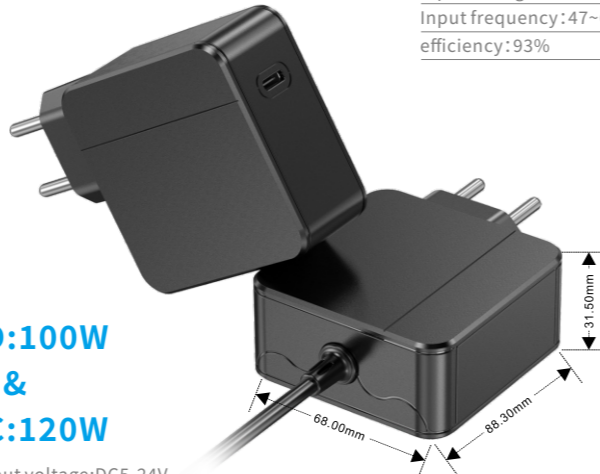

**PD:100W  
&  
DC:120W**

output voltage:DC5-24V  
output current:0.1-8A  
PD3.0/MTK/FCP/AFC/APPLE/SCP/QC4.0/QC3.0/QC2.0/PPS  
product certificate: CB, BR(ROHS/REACH/ICES/ERP)

SHENZHENSHI JIHONGDA POWER. CO. LTD.

# 100W GaN方案

**JHD MORE+** www.jhdpower.com

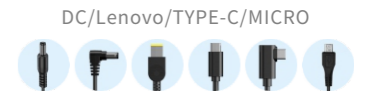

## Kc韩国

**InputCharacteristics**  
Input voltage:100-240VAC  
Input frequency:47~63HZ  
efficiency:93%

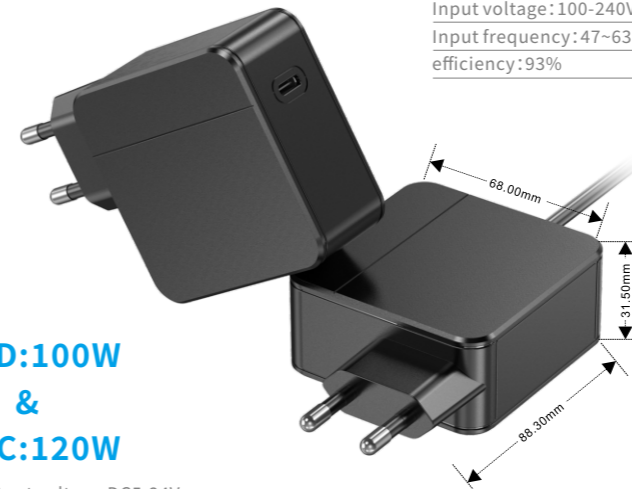

**PD:100W  
&  
DC:120W**

output voltage:DC5-24V  
output current:0.1-8A  
PD3.0/MTK/FCP/AFC/APPLE/SCP/QC4.0/QC3.0/QC2.0/PPS  
product certificate: CB, KC, KCC(MEPS/ROHS/REACH/ERP)

## BIS印度规

**InputCharacteristics**  
Input voltage:100-240VAC  
Input frequency:47~63HZ  
efficiency:93%

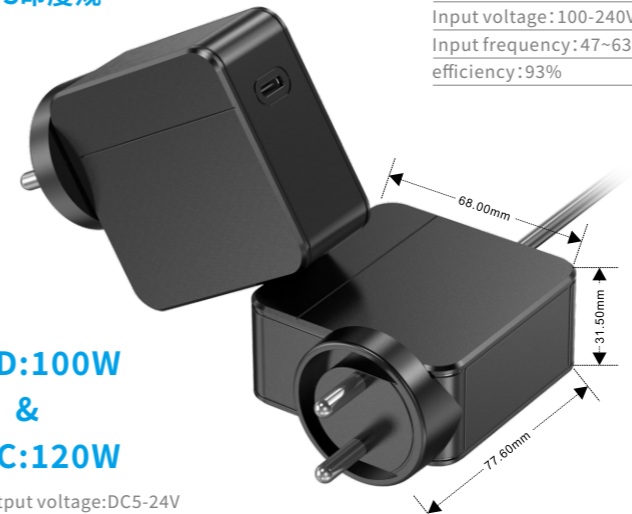

**PD:100W  
&  
DC:120W**

output voltage:DC5-24V  
output current:0.1-8A  
PD3.0/MTK/FCP/AFC/APPLE/SCP/QC4.0/QC3.0/QC2.0/PPS  
product certificate: CB, BIS(/ROHS/REACH/ERP)

## SAA澳大利亚

**InputCharacteristics**  
Input voltage:100-240VAC  
Input frequency:47~63HZ  
efficiency:93%



**PD:100W  
&  
DC:120W**

output voltage:DC5-24V  
output current:0.1-8A  
PD3.0/MTK/FCP/AFC/APPLE/SCP/QC4.0/QC3.0/QC2.0/PPS  
product certificate: SAA, C-tick (GEMS/ROHS/REACH/ERP)

深圳市吉宏达电子有限公司

## S-MARK阿根廷

**InputCharacteristics**  
Input voltage:100-240VAC  
Input frequency:47~63HZ  
efficiency:93%

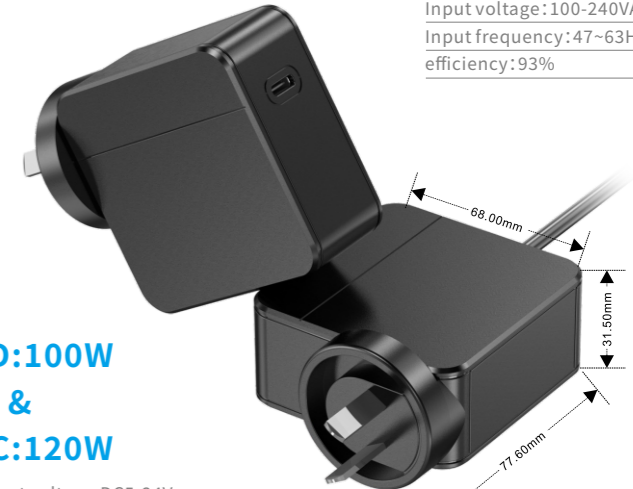

**PD:100W  
&  
DC:120W**

output voltage:DC5-24V  
output current:0.1-8A  
PD3.0/MTK/FCP/AFC/APPLE/SCP/QC4.0/QC3.0/QC2.0/PPS  
product certificate: CB, S-MARK(ROHS/REACH/ERP)

## Bs英国

**InputCharacteristics**  
Input voltage:100-240VAC  
Input frequency:47~63HZ  
efficiency:93%

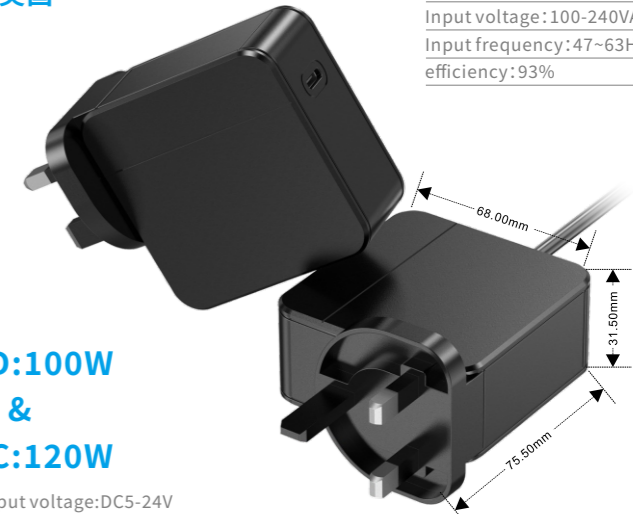

**PD:100W  
&  
DC:120W**

output voltage:DC5-24V  
output current:0.1-8A  
PD3.0/MTK/FCP/AFC/APPLE/SCP/QC4.0/QC3.0/QC2.0/PPS  
product certificate: CB, UKCA(ROHS/REACH/ERP)

## C8桌面式

**InputCharacteristics**  
Input voltage:100-240VAC  
Input frequency:47~63HZ  
efficiency:93%



**PD:100W  
&  
DC:120W**

output voltage:DC5-24V  
output current:0.1-8A  
PD3.0/MTK/FCP/AFC/APPLE/SCP/QC4.0/QC3.0/QC2.0/PPS  
product certificate: CCC\UL\FCC\PSE\KC\KCC\CE\UKCA\EAC\BIS\SAA\S-MARK  
BR (CECP/MEPS//DOE/CEC/ICES/GEMS/ERP/ROHS/REACH)

SHENZHENSHI JIHONGDA POWER. CO. LTD.

# 100W GaN方案

JHD MORE+ www.jhdpower.com



## C6桌面式

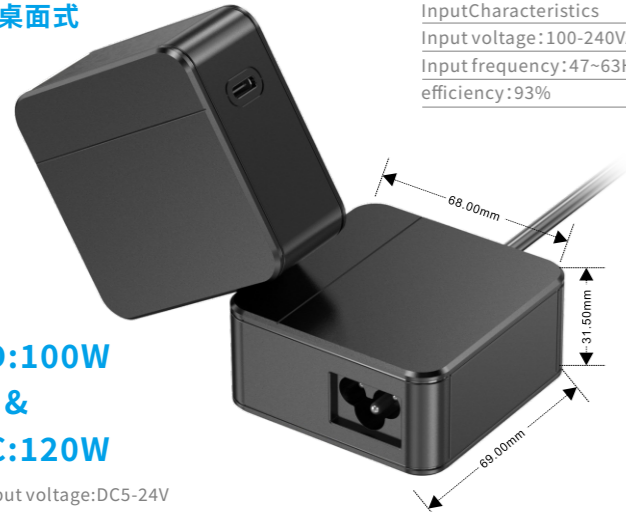

**InputCharacteristics**  
Input voltage:100-240VAC  
Input frequency:47~63HZ  
efficiency:93%

### PD:100W & DC:120W

output voltage:DC5-24V  
output current:0.1-8A  
PD3.0/MTK/FCP/AFC/APPLE/SCP/QC4.0/QC3.0/QC2.0/PPS  
product certificate: CCC\UL\FCC\PSE\KC\KCC\CE\UKCA\EAC\BIS\SAA\S-MARK  
BR (CECP/MEPS//DOE/CEC/ICES/GEMS/ERP/ROHS/REACH)

## SAA澳规直插式

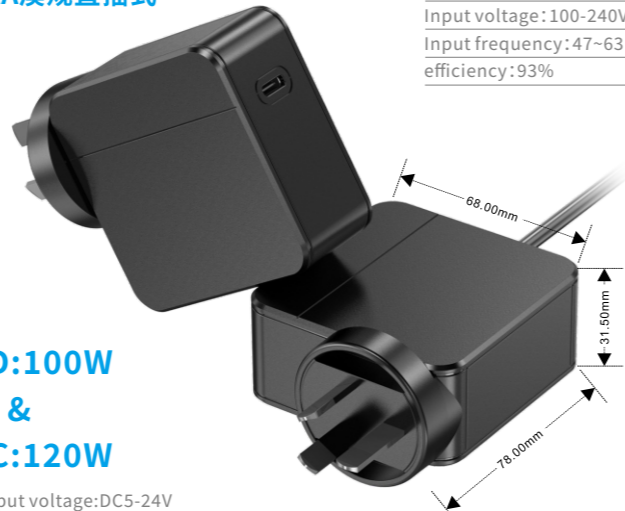

**InputCharacteristics**  
Input voltage:100-240VAC  
Input frequency:47~63HZ  
efficiency:93%

### PD:100W & DC:120W

output voltage:DC5-24V  
output current:0.1-8A  
PD3.0/MTK/FCP/AFC/APPLE/SCP/QC4.0/QC3.0/QC2.0/PPS  
product certificate: SAA, C-tick (GEMS/ROHS/REACH/ERP)

## CE欧规直插式

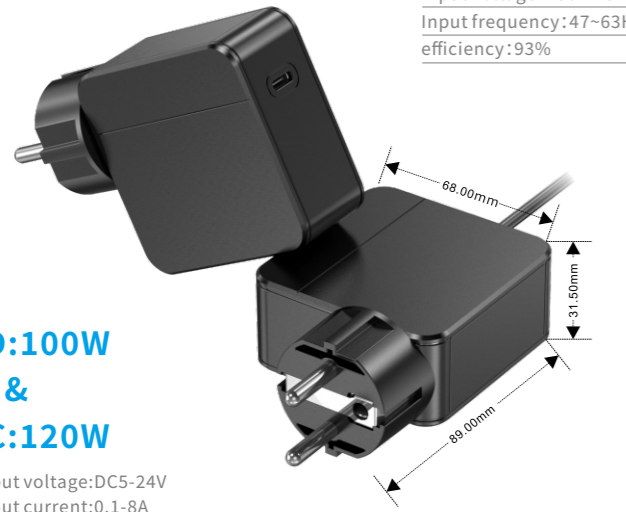

**InputCharacteristics**  
Input voltage:100-240VAC  
Input frequency:47~63HZ  
efficiency:93%

### PD:100W & DC:120W

output voltage:DC5-24V  
output current:0.1-8A  
PD3.0/MTK/FCP/AFC/APPLE/SCP/QC4.0/QC3.0/QC2.0/PPS  
product certificate: CB, CE, EAC(ROHS/REACH/ICES/ERP)

## UL美规/PSE日规直插式

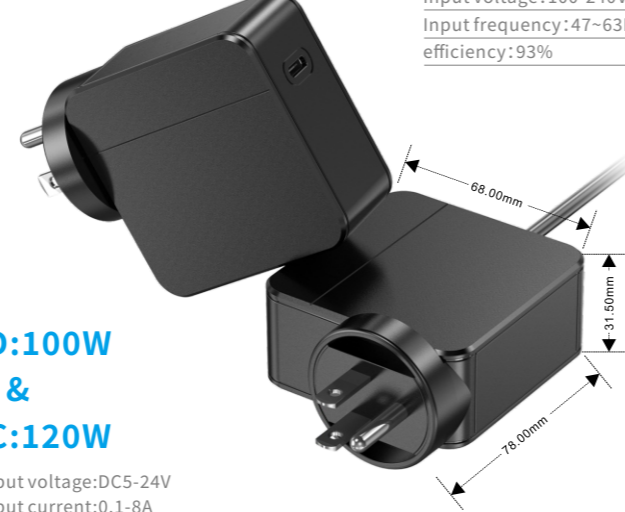

**InputCharacteristics**  
Input voltage:100-240VAC  
Input frequency:47~63HZ  
efficiency:93%

### PD:100W & DC:120W

output voltage:DC5-24V  
output current:0.1-8A  
PD3.0/MTK/FCP/AFC/APPLE/SCP/QC4.0/QC3.0/QC2.0/PPS  
product certificate: CB, UL, FCC, PSE(ROHS/REACH/DOE/CEC/ICES)

## CCC中规直插式

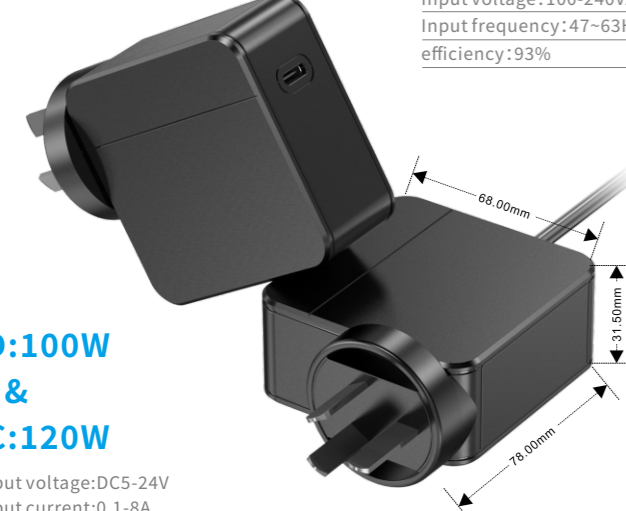

**InputCharacteristics**  
Input voltage:100-240VAC  
Input frequency:47~63HZ  
efficiency:93%

### PD:100W & DC:120W

output voltage:DC5-24V  
output current:0.1-8A  
PD3.0/MTK/FCP/AFC/APPLE/SCP/QC4.0/QC3.0/QC2.0/PPS  
product certificate: CB, CCC(CECP)

## S-MARK阿根廷规直插式

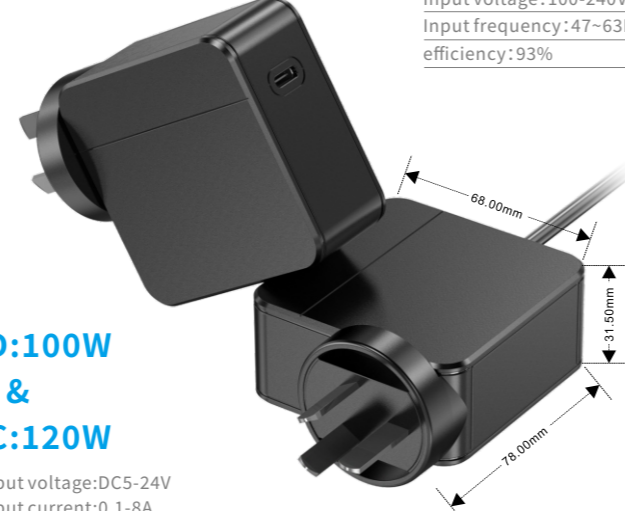

**InputCharacteristics**  
Input voltage:100-240VAC  
Input frequency:47~63HZ  
efficiency:93%

### PD:100W & DC:120W

output voltage:DC5-24V  
output current:0.1-8A  
PD3.0/MTK/FCP/AFC/APPLE/SCP/QC4.0/QC3.0/QC2.0/PPS  
product certificate: CB, S-MARK(ROHS/REACH/ERP)

JHD MORE+ www.jhdpower.com

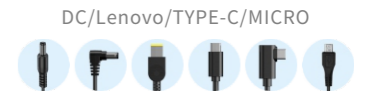

## 100W-C6桌面式

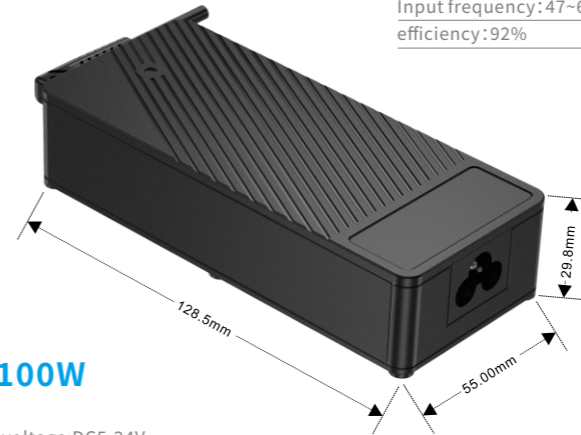

**InputCharacteristics**  
Input voltage:100-240VAC  
Input frequency:47~63HZ  
efficiency:92%

### DC:100W

output voltage:DC5-24V  
output current:0.1-8A  
DC:12V8A/19V6.32A/20V6A/24V5A  
product certificate: CCC\UL\FCC\PSE\CE\UKCA\EAC(CECP/DOE/CEC/ICES  
/ERP/ROHS/REACH)

## CCC中规

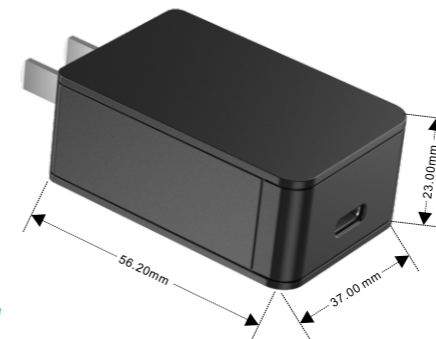

**InputCharacteristics**  
Input voltage:100-240VAC  
Input frequency:47~63HZ  
efficiency:92%

### PD:20W

output voltage:DC5-12V  
output current:0.1-3A  
PD3.0/MTK/FCP/AFC/APPLE/SCP/PPS  
product certificate: CB, CCC(CECP)

## 120W-C6桌面式

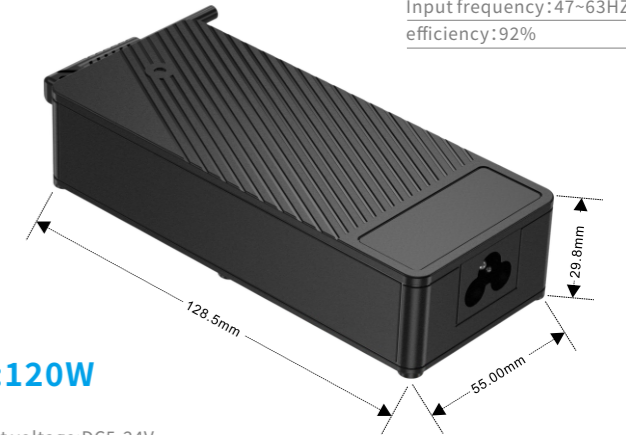

**InputCharacteristics**  
Input voltage:100-240VAC  
Input frequency:47~63HZ  
efficiency:92%

### DC:120W

output voltage:DC5-24V  
output current:0.1-8A  
DC:12V8A/19V6.32A/20V6A/24V5A  
product certificate: CCC\UL\FCC\PSE\CE\UKCA\EAC(CECP/DOE/CEC/ICES  
/ERP/ROHS/REACH)

## CE欧规/EAC俄罗斯

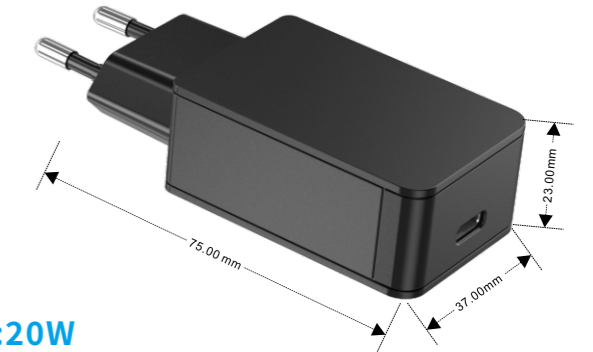

**InputCharacteristics**  
Input voltage:100-240VAC  
Input frequency:47~63HZ  
efficiency:92%

### PD:20W

output voltage:DC5-12V  
output current:0.1-3A  
PD3.0/MTK/FCP/AFC/APPLE/SCP/PPS  
product certificate: CB, CE, EAC(ROHS/REACH/ICES/ERP)

# PD20W---A+C快充

CCC中規

InputCharacteristics  
Input voltage:100-240VAC  
Input frequency:47~63HZ  
efficiency:88%

PD:20W

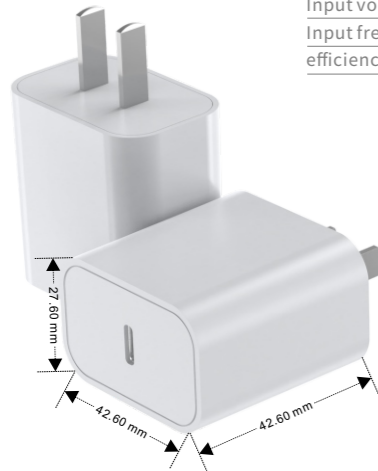

output voltage:DC5-12V  
output current:0.1-3A  
PD3.0/MTK/FCP/AFC/APPLE/SCP/PPS  
product certificate: CB, CCC(CECP)

UL美規/PSE日規  
NOM墨西哥/BSMI台灣

InputCharacteristics  
Input voltage:100-240VAC  
Input frequency:47~63HZ  
efficiency:88%

PD:20W

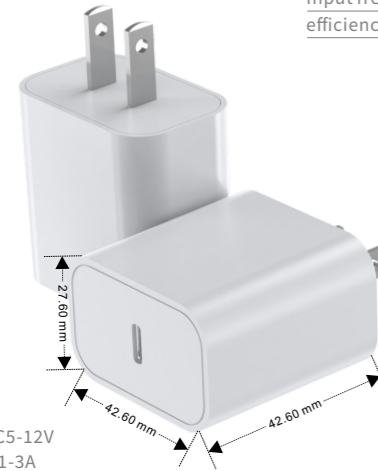

output voltage:DC5-12V  
output current:0.1-3A  
PD3.0/MTK/FCP/AFC/APPLE/SCP/PPS  
product certificate: CB, UL, FCC, PSE  
(ROHS/REACH/DOE/CEC/ICES)

CE歐規/EAC俄羅斯

InputCharacteristics  
Input voltage:100-240VAC  
Input frequency:47~63HZ  
efficiency:88%

PD:20W

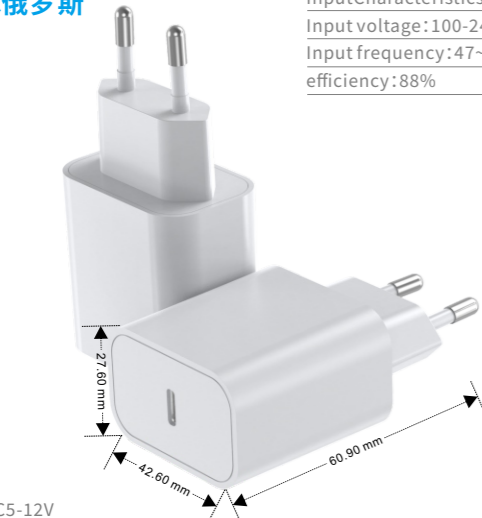

output voltage:DC5-12V  
output current:0.1-3A  
PD3.0/MTK/FCP/AFC/APPLE/SCP/PPS  
product certificate: CB, CE, EAC(ROHS/REACH/ICES/ERP)

CCC中規

InputCharacteristics  
Input voltage:100-240VAC  
Input frequency:47~63HZ  
efficiency:88%

PD:20W  
&  
QC:18W



output voltage:DC5-12V  
output current:0.1-3A  
PD3.0/MTK/FCP/AFC/APPLE/SCP/QC4.0/QC3.0/QC2.0/PPS  
product certificate: CB, CCC(CECP)

輸出模式:  
单独使用USB-A时最大18W快充(QC)  
单独使用Type-c时最大20W快充(PD)  
同时使用Type-c+USB-A时不支持快充协议只有5V3A(15W)输出

UL美規/PSE日規  
NOM墨西哥/BSMI台灣

InputCharacteristics  
Input voltage:100-240VAC  
Input frequency:47~63HZ  
efficiency:88%

PD:20W  
&  
QC:18W

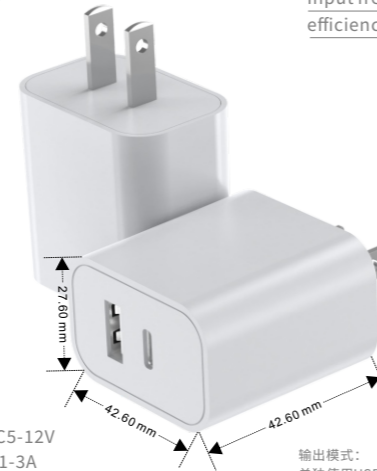

output voltage:DC5-12V  
output current:0.1-3A  
PD3.0/MTK/FCP/AFC/APPLE/SCP/QC4.0/QC3.0/QC2.0/PPS  
product certificate: CB, UL, FCC, PSE  
(ROHS/REACH/DOE/CEC/ICES)

輸出模式:  
单独使用USB-A时最大18W快充(QC)  
单独使用Type-c时最大20W快充(PD)  
同时使用Type-c+USB-A时不支持快充协议只有5V3A(15W)输出

CE歐規/EAC俄羅斯

InputCharacteristics  
Input voltage:100-240VAC  
Input frequency:47~63HZ  
efficiency:88%

PD:20W  
&  
QC:18W

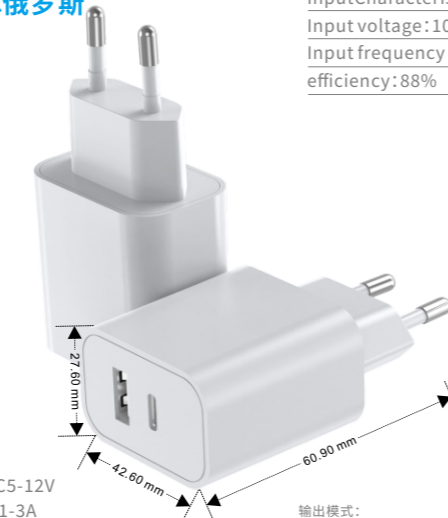

output voltage:DC5-12V  
output current:0.1-3A  
PD3.0/MTK/FCP/AFC/APPLE/SCP/QC4.0/QC3.0/QC2.0/PPS  
product certificate: CB, CE, EAC  
(ROHS/REACH/ICES/ERP)

輸出模式:  
单独使用USB-A时最大18W快充(QC)  
单独使用Type-c时最大20W快充(PD)  
同时使用Type-c+USB-A时不支持快充协议只有5V3A(15W)输出

# PD20W---A+C快充

Bs英國

InputCharacteristics  
Input voltage:100-240VAC  
Input frequency:47~63HZ  
efficiency:88%

PD:20W

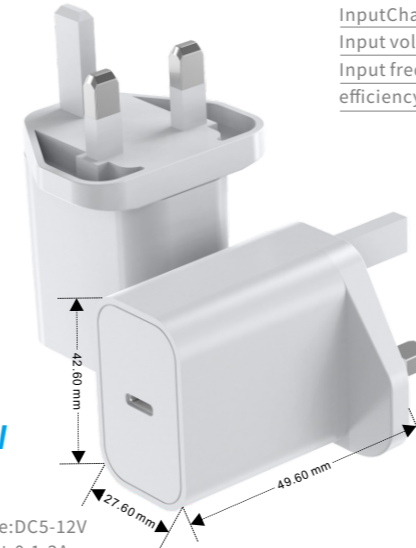

output voltage:DC5-12V  
output current:0.1-3A  
PD3.0/MTK/FCP/AFC/APPLE/SCP/PPS  
product certificate: CB, UKCA(ROHS/REACH/ERP)

Bs英國

InputCharacteristics  
Input voltage:100-240VAC  
Input frequency:47~63HZ  
efficiency:88%

PD:20W  
&  
QC:18W

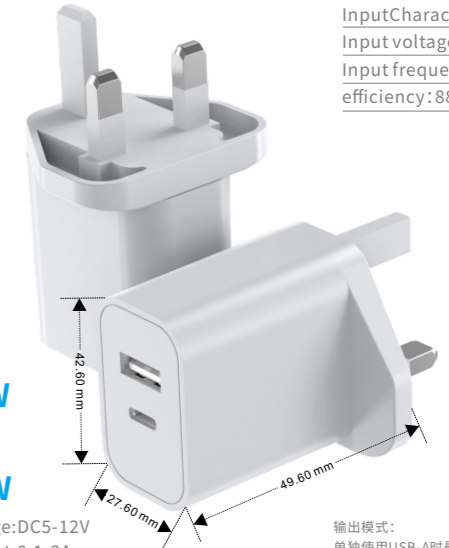

output voltage:DC5-12V  
output current:0.1-3A  
PD3.0/MTK/FCP/AFC/APPLE/SCP/QC4.0/QC3.0/QC2.0/PPS  
product certificate: CB, UKCA(ROHS/REACH/ERP)

輸出模式:  
单独使用USB-A时最大18W快充(QC)  
单独使用Type-c时最大20W快充(PD)  
同时使用Type-c+USB-A时不支持快充协议只有5V3A(15W)输出

# PD30W---A+C快充

CCC中規



**PD:30W**  
&  
**QC:18W**

PD3.0/MTK/FCP/AFC/APPLE/SCP/QC4.0/QC3.0/QC2.0/PPS  
product certificate: **CB, CCC(CECP)**

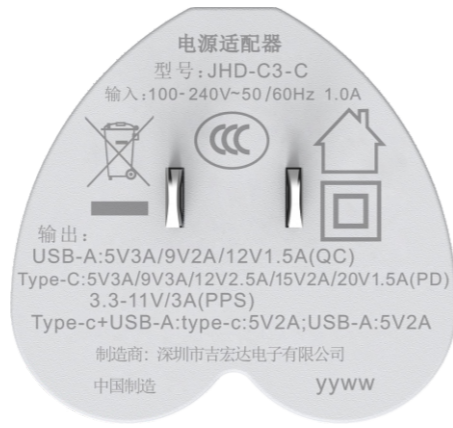

输出模式:  
单独使用USB-A时最大18W快充(QC)  
单独使用Type-c时最大30W快充 (PD)  
同时使用Type-c + USB-A时不支持快充协议  
只有5V2A(10W)输出

# PD30W---A+C快充

BS英規



**PD:30W**  
&  
**QC:18W**

PD3.0/MTK/FCP/AFC/APPLE/SCP/QC4.0/QC3.0/QC2.0/PPS  
product certificate: **CB, UKCA(ROHS/REACH/ERP)**

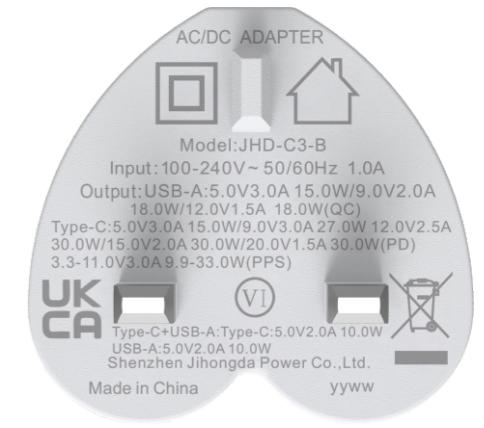

输出模式:  
单独使用USB-A时最大18W快充(QC)  
单独使用Type-c时最大30W快充 (PD)  
同时使用Type-c + USB-A时不支持快充协议  
只有5V2A(10W)输出

UL美規/PSE日規



**PD:30W**  
&  
**QC:18W**

PD3.0/MTK/FCP/AFC/APPLE/SCP/QC4.0/QC3.0/QC2.0/PPS  
product certificate: **CB, UL, FCC, PSE(ROHS/REACH/DOE/CEC/ICES)**

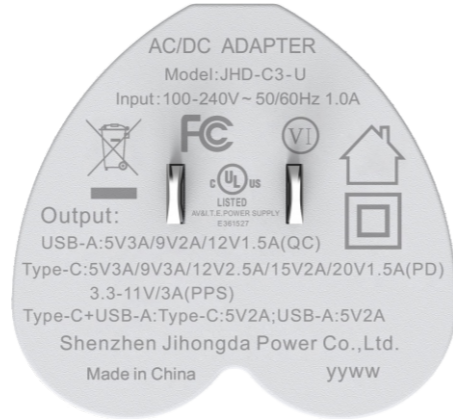

输出模式:  
单独使用USB-A时最大18W快充(QC)  
单独使用Type-c时最大30W快充 (PD)  
同时使用Type-c + USB-A时不支持快充协议  
只有5V2A(10W)输出

CE欧規/EAC俄罗斯



**PD:30W**  
&  
**QC:18W**

PD3.0/MTK/FCP/AFC/APPLE/SCP/QC4.0/QC3.0/QC2.0/PPS  
product certificate: **CB, CE, EAC(ROHS/REACH/ICES/ERP)**

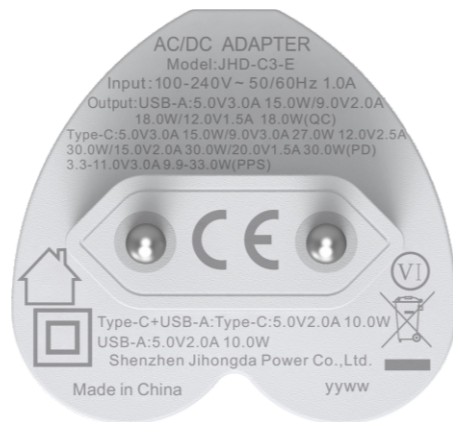

输出模式:  
单独使用USB-A时最大18W快充(QC)  
单独使用Type-c时最大30W快充 (PD)  
同时使用Type-c + USB-A时不支持快充协议  
只有5V2A(10W)输出